



XDVD9101

INSTALLATION/OWNER'S MANUAL

DVD Multimedia Receiver with 7" Touch Screen Display



Safety Notes:

The DVD video display of the in-dash unit will not operate while the vehicle is moving. This is a safety feature to prevent driver distraction. In-dash DVD video functions will only operate when vehicle is in Park and the parking brake is engaged. It is illegal in most states for the driver to view video while the vehicle is in motion.

Copyright Notes

This product incorporates copyright protection technology that is protected by method claims of certain U.S. patents and other intellectual property rights owned by Macrovision Corporation and other rights owners. Use of this copyright protection technology must be authorized by Macrovision Corporation, and is intended for home and other limited viewing uses only unless otherwise authorized by Macrovision Corporation. Reverse engineering or disassembly is prohibited.

Manufactured under license from Dolby Laboratories. "Dolby" and the double-D symbol are trademarks of Dolby Laboratories.

Windows Media and the Windows logo are trademarks, or registered trademarks of Microsoft Corporation in the United States and other countries.

iPod is a trademark of Apple Computer, Inc., registered in the U.S. and other countries.

All other trademarks are property of their respective owners.

Table of Contents

	Page
Warning Statement	3
Safety Information/Precautions	4
Preparation/Mounting/Wiring	5-7
Remote Control Overview	8
Control Locations - Monitor Closed	9-11
Control Locations - Monitor Open	12
Control Locations - Remote	13-14
General Operation	15-17
Main Setup Menu	18-22
Screen Setup Menu	23-26
AM/FM Tuner Operation	27-30
Warning Statement	31
DVD Setup	32-38
DVD Operation	39-42
CD Operation	43-46
MP3/WMA/JPG Operation	47-50
USB Operation	51-54
Media Compatibility Information	55-57
iPod Operation	58-63
Auxiliary Inputs	64
Rear Camera Operation	64
Warranty	65
Specifications	66
Troubleshooting	67



XDVD9101 PREPARATION

⚠ WARNING ⚠

Upon installation of this Monitor/DVD player (“unit”) into a vehicle, the driver of the vehicle must not operate this unit by watching videos or playing video games while driving. Failure to follow this instruction could lead to driver distraction which could result in serious injury or death to the vehicle’s occupants or persons outside the vehicle and/or property damage.

Several states prohibit the installation of monitors/DVD players if the screen is visible from the driver’s seat. If you reside in a jurisdiction which has enacted such a law, this unit must not be installed so that the screen is visible from the driver’s seat. When installing this unit in the front console/dashboard, the unit must be positioned so that it is facing the front passenger seat only. Failure to follow this instruction could lead to driver distraction which could result in serious injury or death to the vehicle’s occupants or persons outside the vehicle and/or property damage.

This unit is designed so that it may be operated only when the vehicle is in “Park” and the parking brake is fully engaged. To this end, this unit includes a parking brake lock-out feature which prohibits the unit from operating if the vehicle is not in “Park” and/or the parking brake is not fully engaged. When installing this unit, the installer must connect the parking brake detect wire (“Yellow-Blue Lead”) to the parking brake mechanism in order to make the parking brake lock-out feature operable. DO NOT simply ground the parking brake detect wire to a metal portion of the vehicle. Failure to properly install the parking brake lock-out feature could lead to driver distraction which could result in serious injury or death to the driver’s occupants or persons outside the vehicle and/or property damage.

Once the parking brake lock-out feature is installed, the owner/user must not attempt to disrupt/neutralize the parking brake lock-out feature by (a) partially engaging the parking brake and/or (b) purchasing/using any device or unit designed to send necessary brake signals to the unit. Failure to follow these instructions could lead to driver distraction which could result in serious injury or death to the driver’s occupants or persons outside the vehicle and/or property damage.

When operating this unit, keep the unit’s volume level low enough so that the vehicle’s occupants can hear traffic-related sounds such as police and emergency vehicles. Failure to follow this instruction could lead to driver distraction which could result in serious injury or death to the vehicle’s occupants or persons outside the vehicle and/or property damage.

Safety Information

Please read all instructions carefully before attempting to install or operate.

Due to its technical nature, it is highly recommended that your DUAL XDVD9101 is installed by a professional installer or an authorized dealer. This product is only for use in vehicles with 12VDC negative ground only.

Safety Notes:

The DVD video display of the in-dash unit will not operate while the vehicle is moving. This is a safety feature to prevent driver distraction. In-dash DVD video functions will only operate when vehicle is in Park and the parking brake is engaged. It is illegal in most states for the driver to view video while the vehicle is in motion.

To prevent damage or injury:

1. Make sure to ground the unit securely to the vehicle chassis ground.
2. Do not remove the top or bottom covers of the unit.
3. Do not install the unit in a spot exposed to direct sunlight or excessive heat or the possibility of water splashing.
4. Do not subject the unit to excessive shock.
5. When replacing a fuse, only use a new one with the prescribed rating. Using a fuse with the wrong rating may cause the unit to malfunction.
6. To prevent short circuits when replacing a fuse, disconnect the wiring harness first.
7. Use only the provided hardware and wire harness.
8. You cannot view video while the vehicle is moving. Find a safe place to park and engage the parking brake.
9. If you experience problems during installation, consult your nearest DUAL dealer.
10. If the unit malfunctions, reset the unit as described on page 10 first. If the problem still persists, consult your nearest DUAL dealer or call tech assistance @ 1-866-382-5476.
11. To clean the monitor, wipe only with a dry silicone cloth or soft cloth. Do not use a stiff cloth, or volatile solvents such as paint thinner and alcohol. They can scratch the surface of the panel and/or remove the printing.
12. When the temperature of the unit falls (as in winter), the liquid crystal inside the screen will become darker than usual. Normal brightness will return after using the monitor for a while.

Additional Notes:

1. When extending the ignition, battery or ground cables, make sure to use automotive-grade cables or other cables with an area of 0.75mm (AWG 18) or more to prevent voltage drops.
2. Do not touch the liquid crystal fluid if the LCD is damaged or broken. The liquid crystal fluid may be hazardous to your health or fatal. If the liquid crystal fluid from the LCD contacts your body or clothing, wash it off with soap immediately.

This device complies with part 15 of the FCC rules and regulations.

Operation is subject to the following two conditions:

- 1) This device may not cause harmful interference, and
- 2) This device must accept any interference received, including interference that may cause undesired operation.



XDVD9101 INSTALLATION

Preparation

Please read entire manual before installation.

Before You Start

- Disconnect negative battery terminal. Consult a qualified technician for instructions.
- Avoid installing the unit where it would be subject to high temperatures, such as from direct sunlight, or where it would be subject to dust, dirt or excessive vibration.

Getting Started

- Remove 3 transit screws located on top of the unit.
- Insert the supplied keys into the slots as shown, and slide the unit out of the mounting sleeve.
- Install mounting sleeve into opening, bending tabs to secure.
- Connect wiring harness and antenna as shown on pages 6-7. Consult a qualified technician if you are unsure.
- Certain vehicles may require an installation kit and/or wiring harness adapter (sold separately).
- Test for correct operation and slide unit into mounting sleeve to secure.
- Snap trim ring into place.

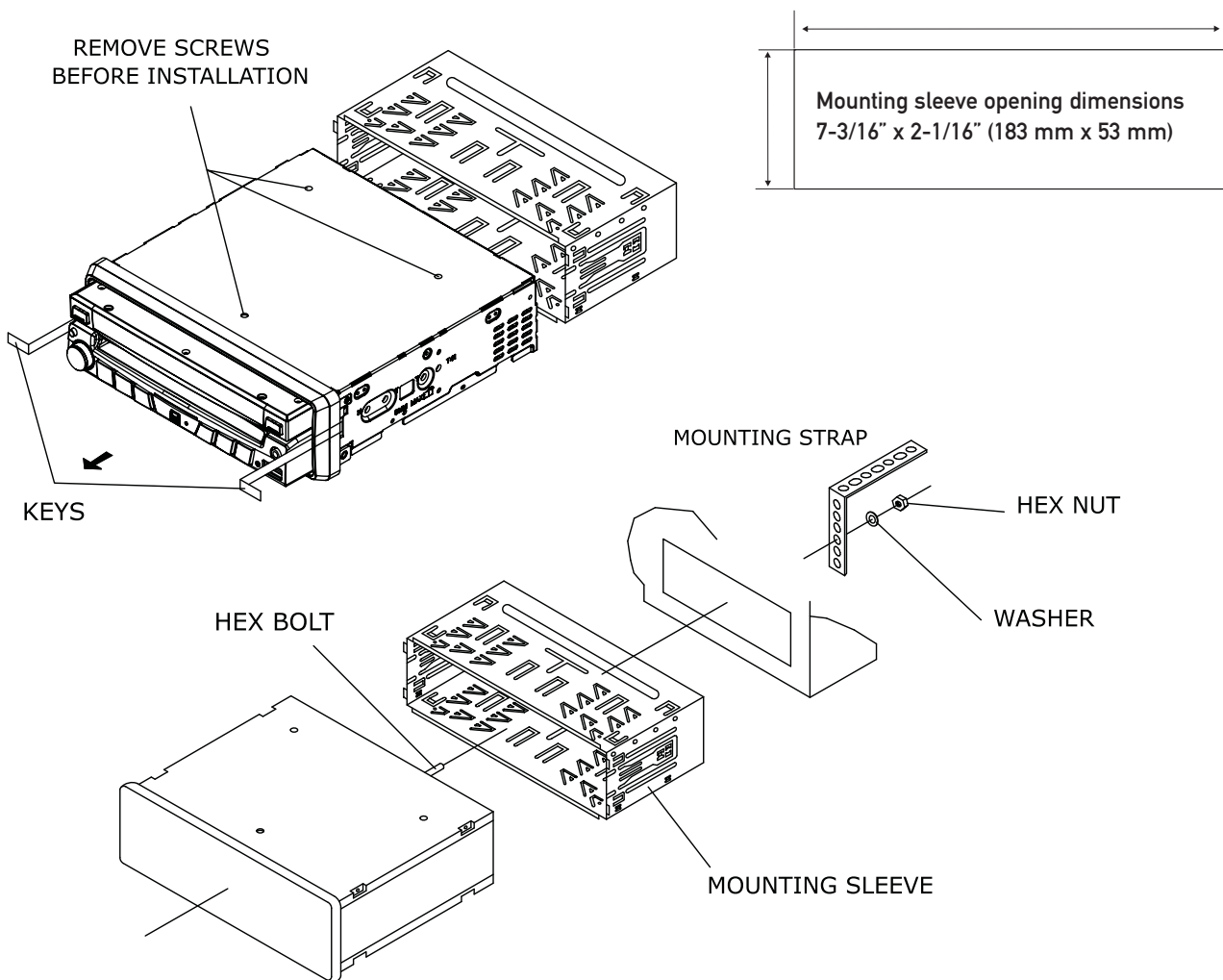

TYPICAL FRONT-LOAD DIN MOUNTING METHOD

Wiring Diagram - Inputs/Outputs

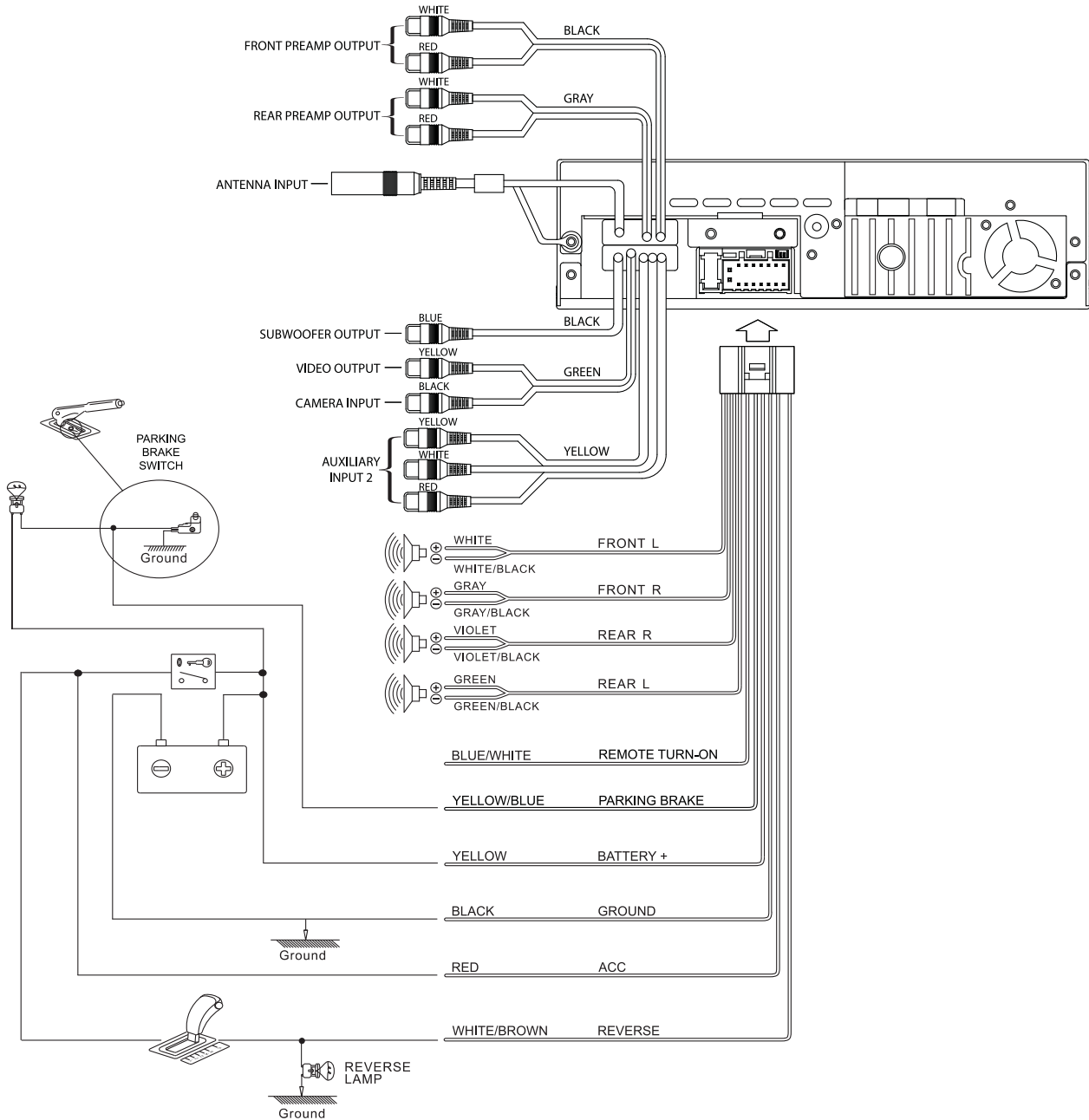

Wiring Notes:

Subwoofer output

The SUBWOOFER audio output (Blue RCA) is active in all audio modes and must be connected to an external amplifier.

Rear view camera

A rear view camera (not included) can be used with the CAMERA input. Refer to page 64 for details.

Need help?

Call our Technical Service Hotline, 1-866-382-5476.



XDVD9101 INSTALLATION

Wiring Diagram - Optional A/V Connections

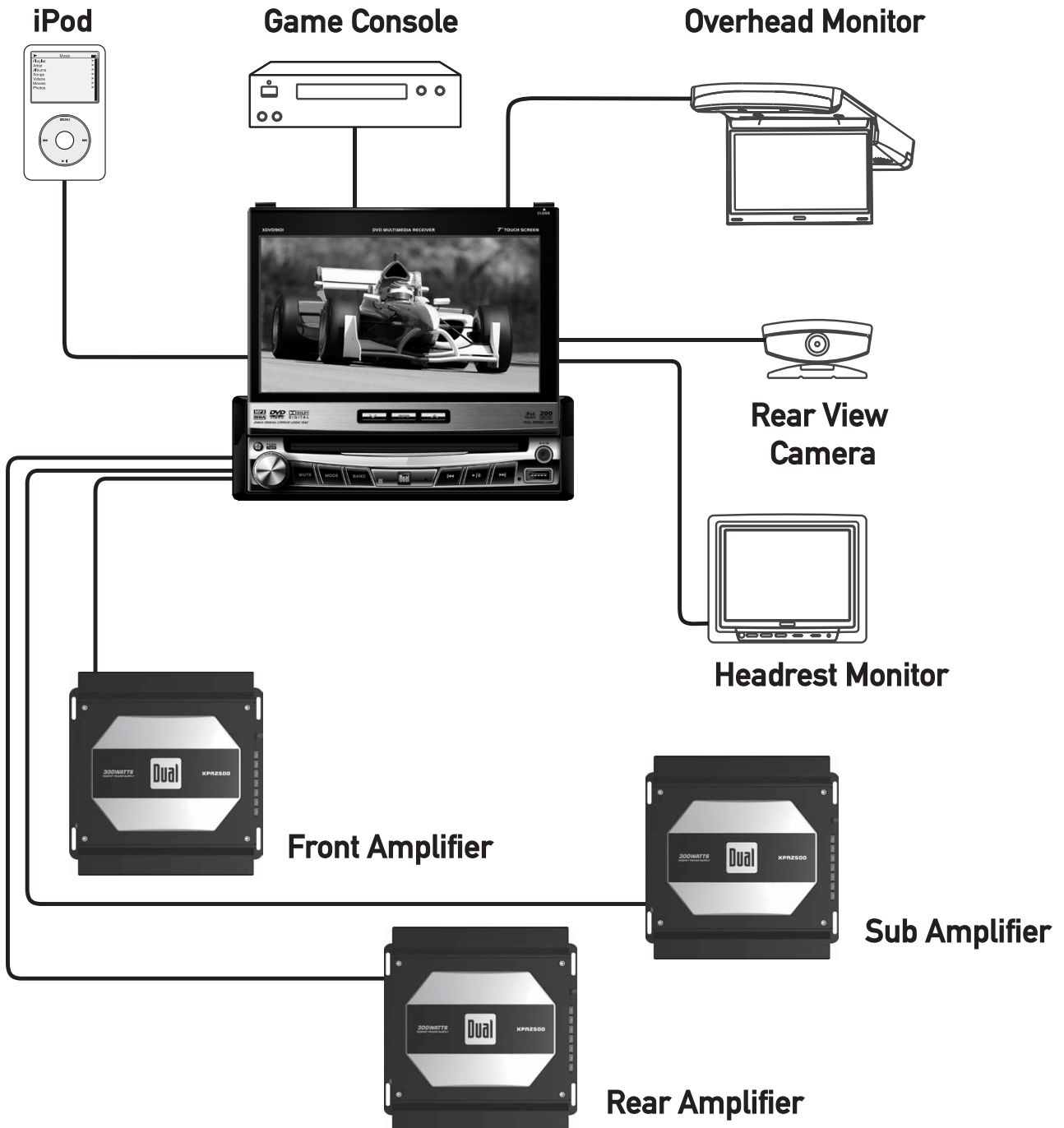

IR Remote Preparation

To first use the IR Remote control, you must first pull the battery insulation tape out

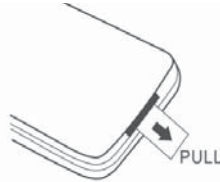

To insert or replace the battery:

Remove the battery holder

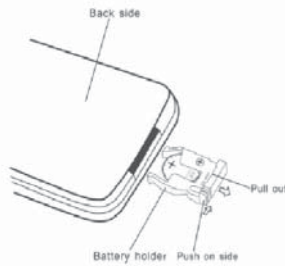

Remove the battery from the battery holder

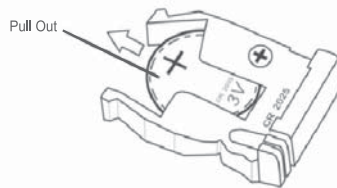

Install the new battery
Make sure to keep the (+) side up

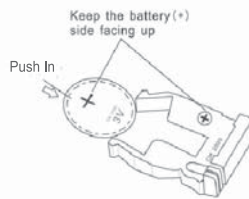

Insert the battery holder

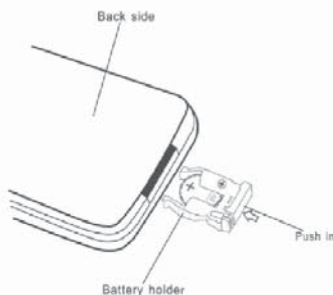

Notes:

- Remove the battery if the remote will not be used for a month or longer
- Remove and dispose of battery properly



CAUTION!!!

- Do not store battery with metallic objects or materials

Control Locations - Monitor Closed

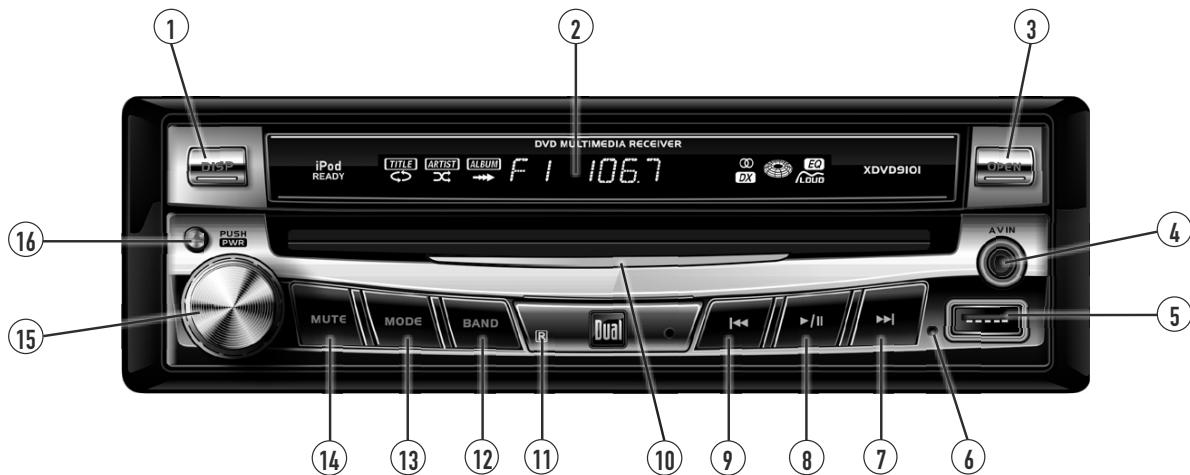

- | | |
|---|---|
| ① Display | ⑨ Channel/Chapter/Track Down/Fast Reverse |
| ② Secondary LCD | ⑩ Disc-In Indicator |
| ③ Open/Close Monitor | ⑪ Infrared Sensor |
| ④ 3.5mm A/V Input | ⑫ Band/Disc Stop |
| ⑤ USB Input | ⑬ Mode |
| ⑥ Reset | ⑭ Mute/Loudness |
| ⑦ Channel/Chapter/Track Up/Fast Forward | ⑮ Power/Volume/EQ |
| ⑧ Play/Pause | ⑯ Eject |

Secondary LCD Information

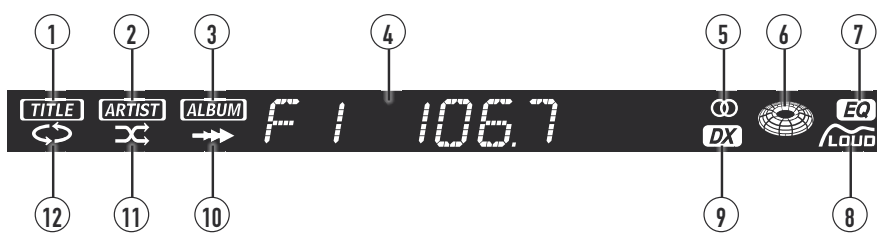

- | | |
|----------------------------|----------------------|
| ① Song title indicator | ⑦ EQ indicator |
| ② Artist name indicator | ⑧ Loudness indicator |
| ③ Album name indicator | ⑨ Distance indicator |
| ④ Main information display | ⑩ Intro indicator |
| ⑤ Stereo indicator | ⑪ Random indicator |
| ⑥ Disc-in indicator | ⑫ Repeat indicator |

Note: Secondary LCD only functions when TFT monitor is closed.

Control Functions - Monitor Closed

Display	When the monitor is closed, press DISP to toggle display between information available for the current mode such as clock, frequency, track or chapter information.
Secondary LCD	Additional LCD for system information while monitor is closed.
Open Monitor	Press OPEN to open or close the monitor. Be careful not to touch or obstruct the monitor movement during the open/close sequence, or permanent damage could occur.
3.5mm A/V Input	Connect external devices to this 3.5mm auxiliary audio/video input.
USB Input	Insert USB flash drive to play MP3, WMA or JPEG files.
Reset	To resolve abnormal operation or if the unit is inoperable, press the RESET button located to the left of the USB input on the front panel. The unit will reset the main processor to the default settings. Note: Use the tip of a pen to access the reset button. To restore the factory default settings, refer to page 19.
Channel/Chapter/Track Up Fast Forward	Press to select the next channel/chapter/track for playback. Press and hold to manual tune up or fast forward.
Play/Pause	In disc mode, press once for PAUSE , and "PAUSE" will appear in the display. Press again to resume PLAY .
Channel/Chapter/Track Down Fast Reverse	Press to select the previous channel/chapter/track for playback. Press and hold to manual tune down or fast reverse.
Disc-in Indicator	Red = Disc inserted, Blue = No disc.
Infrared Sensor	Point the remote control towards the infrared sensor to control various functions of the unit.
Band	Press BAND to increment from FM1, FM2, ⇔ AM. While in disc mode, press BAND momentarily to stop disc play.
Mode	Press MODE to select between Tuner, Disc (which includes DVD and CD playback), iPod, USB, Auxiliary 1 and Auxiliary 2 inputs. Each time the MODE button is pressed the next mode is chosen. Modes of operation are indicated on the OSD or the secondary LCD. iPod and USB flash drive (optional) must be connected/inserted to appear in the MODE selection string.
Mute	Press MUTE to silence audio output. "MUTE" will flash in the secondary display. Press MUTE again to restore audio at previous volume level. Press and hold MUTE to toggle the Loudness function On or Off.
Eject	Press  once to eject disc.



Control Functions - Monitor Closed

Power	Momentarily press PWR or any other button (except EJECT) to turn the unit on. Press PWR for more than 3 seconds to turn the unit off.
Volume	Turn the rotary to adjust the volume level lower or higher (0-46). The current volume level will be displayed on the secondary LCD when the monitor is closed. Turning the rotary while the volume is muted will cancel the mute function.
• • • • • • • •	Press the volume knob momentarily to select between Flat, Classic, Pop, Rock or User EQ presets.
Caution	<ul style="list-style-type: none">• Due to its highly technological design, the XDVD9101 faceplate is NOT removable. Do not attempt to remove the faceplate.• Upon installation, do not attempt to move the monitor by hand. Use the ∨ or ∧ buttons, the OPEN button on the front panel or the remote control.• The unit will stop if it encounters any obstacles during the open/close sequence. If this occurs, remove the obstacle and press OPEN again to resume the monitor open/close sequence.

Control Locations and Functions - Monitor Open



- ① Close Monitor
- ② Screen Angle Up
- ③ Info/Picture
- ④ Screen Angle Down

Close Monitor	Press CLOSE to open or close the monitor. Be careful not to touch or obstruct the monitor movement during the open/close sequence, or permanent damage could occur.
Info/Picture	Press to display DVD disc information in DVD mode. Holding this button for 3 seconds brings up the Brightness setting, which can be adjusted by turning the rotary encoder or by pressing the ◀ or ▶ buttons on the main remote control.
Screen Angle Up	Press momentarily to adjust the angle of the screen upwards. Press and hold to slide the monitor inwards.
Screen Angle Down	Press to adjust the angle of the screen downwards. Press and hold to slide the monitor outwards.
Monitor Notes	<ul style="list-style-type: none"> • The angle can also be manually selected via the screen setup menu. • The color of the LCD monitor varies between viewing angles. Select the angle with the most optimum view for your location. • The last position of the monitor can be saved in memory. When "TFT Auto Open" is set to "On" in the Main Setup menu, the monitor will return to its last position automatically the next time the unit is turned on.

Control Locations - Remote

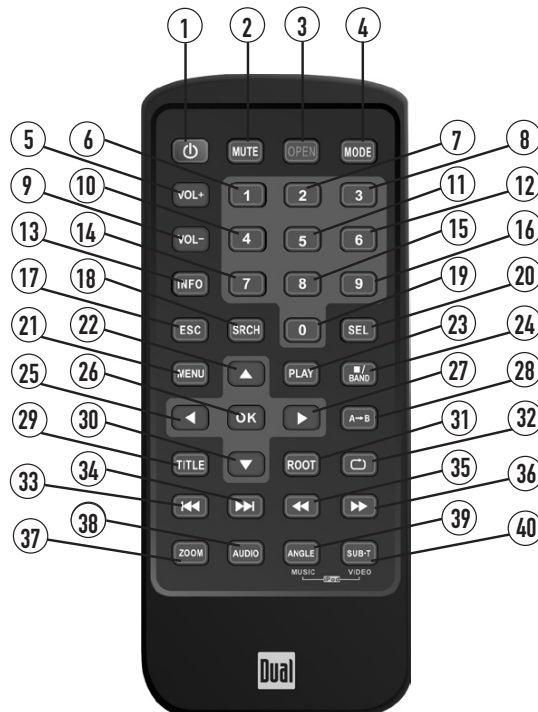





- | | | |
|-----------------|----------|------------------------------------|
| ① Power | ⑩ Key #4 | ⑲ Key #0/DVD Setup |
| ② Mute/Loudness | ⑪ Key #5 | ⑳ Audio Select |
| ③ Open/Close | ⑫ Key #6 | ㉑ Menu |
| ④ Mode | ⑬ Info | ㉒ 4-Way - Up |
| ⑤ Volume Up | ⑭ Key #7 | ㉓ Play |
| ⑥ Key #1 | ⑮ Key #8 | ㉔ Band/Stop |
| ⑦ Key #2 | | ㉕ 4-Way - Left |
| ⑧ Key #3 | | ㉖ OK |
| ⑨ Volume Down | | ㉗ 4-Way - Right |
| | | ㉘ Repeat A-B |
| | | ㉙ Title Menu |
| | | ㉚ 4-Way - Down |
| | | ㉛ Root |
| | | ㉜ Repeat |
| | | ㉝ Chapter/Track/Seek Tune Down |
| | | ㉞ Chapter/Track/Seek Tune Up |
| | | ㉟ Fast Reverse/Manual Tune Down |
| | | ㊱ Fast Forward/Manual Tune Up |
| | | ㊲ Zoom |
| | | ㊳ Audio |
| | | ㊴ Angle/Music mode (iPod only) |
| | | ㊵ Sub-Title/Video mode (iPod only) |

* The remote control uses one 3 volt Lithium CR2025 battery. For best performance, replace only with CR2025 or equivalent.

Control Functions - Remote



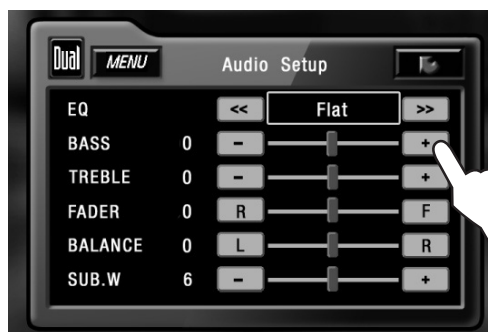

Power	Press once to turn the unit on, press again to turn unit off.
Mute	Press once to MUTE audio; press again to return audio. Press and hold to activate Loudness On/Off.
Open	Press once to open monitor; press again to close the monitor.
Mode	Press once to incrementally select desired source.
Volume Up	Increase VOLUME .
Keys 0-9	Direct access chapter/track/preset stations 1 ~ 9.
Volume Down	Decrease VOLUME .
Info	Displays DVD information.
Escape	Exit current menu.
Search	Search function in Disc and iPod modes.
Audio Select	Enter AUDIO Setup mode.
Menu	Enter the MAIN system menu.
4-Way-Up/Down/Left/Right	Navigating system and DVD menus.
Play	Press to pause/begin playback.
Band/Stop	Press to increment BAND or to STOP while in disc mode.
OK	Press to confirm settings.
Repeat A-B	Repeat playback from time frame A to time frame B.
Title Menu	Enters the title menu of the DVD.
Root Menu	Enters the main menu of the DVD.
Repeat	Repeats playback of current chapter/track or folder.
Chapter/Track/Seek Tune Down	Selects the previous chapter/track/station for playback.
Chapter/Track/Seek Tune Up	Selects the next chapter/track/station for playback.
Fast Reverse/Manual Tune Down	Fast reverses the disc/USB/iPod content, manual tune down.
Fast Forward/Manual Tune Up	Fast forwards the disc/USB/iPod content, manual tune up.
Zoom	Zooming in/out on an image.
Audio	Change the audio language for DVD disc playback.
Angle	Selects between different angles (when available) for a DVD scene/Selects iPod Audio mode.
Sub-Title	Language selection for subtitle/Selects iPod Video mode.

General Operation

Power On/Off	Momentarily press PWR or any other button (except EJECT) to turn the unit on. Hold for 3 seconds to turn the unit off.
Mute	Press MUTE to silence the audio;  will appear in the OSD (On Screen Display). Press MUTE again to cancel.
Loudness	Press LOUD on the OSD to turn the Loudness on/off. Pressing and holding the MUTE button on the front panel or remote will also turn the Loudness on/off.
Mode	Press MODE to select between Tuner, Disc (which includes DVD and CD playback), iPod, USB, Auxiliary 1 and Auxiliary 2 inputs. Modes of operation are indicated on the OSD On Screen Display). iPod and USB flash drive (optional) must be connected/inserted to appear in the MODE selection string.
Optional Mode Selection	Press MENU at the top left corner of the screen to display the OSD main menu. Press Tuner, Disc, iPod, USB, AV/1, AV/2 or Camera in the MAIN menu page to select the desired source.
Volume	Turn the rotary or use the volume  or  to adjust the volume level lower or higher (0-46). The current volume level will be displayed on the secondary LCD when the monitor is closed or on the LCD (to the right of the volume icon ) when the monitor is open. Turning the rotary while the volume is muted will cancel the mute function.
Audio Setup (from OSD)	From Tuner, Disc (CD only), iPod or USB mode, touch EQ on the OSD or press the rotary momentarily to enter the Audio Setup menu. Adjust audio parameters by pressing the desired level you wish to change. Operation will return back to previous mode after 15 seconds of inactivity or by pressing the RETURN arrow in the top right corner.



Audio Setup (from remote)

Press the **SEL** button. Press the  or  buttons on the remote to select an item to be adjusted. Press  or  to decrease (-) or increase (+) the current level. Press **RETURN** on the OSD or the **ESC** button on the remote control to exit the audio control menu.

Note: The Bass and Treble levels are only adjustable when EQ is set to "User" mode. The Loud function compensates for deficiencies in sound ranges at low levels. When the Loud function is on, **LOUD:On** is displayed in the OSD.

General Operation

- Info** Press **INFO** momentarily to display DVD disc information.
- Monitor Brightness** Press and hold **INFO** for 3 seconds to change monitor **BRIGHTNESS**. Turn the rotary ⤴ or ⤵ to adjust to desired level. (0 minimum/20 maximum; 10 is default).
- Color Setup** When a video source is connected to the front or rear auxiliary inputs, press **INFO** for more than 2 seconds to adjust **COLOR SETUP** during video play. Press ⤴ or ⤵ to step to the desired menu option:



- Sharpness** Turn the rotary ⤴ or ⤵ to adjust the sharpness. (0 minimum/+15 maximum).
- Color** Turn the rotary ⤴ or ⤵ to adjust the color. (0 minimum/+20 maximum).
- Contrast** Turn the rotary ⤴ or ⤵ to adjust the contrast. (0 minimum/+20 maximum).
- Brightness** Turn the rotary ⤴ or ⤵ to adjust the brightness. (0 minimum/+20 maximum).
- Tint** Turn the rotary ⤴ or ⤵ to adjust the tint. (0 minimum/+20 maximum).
- Note:** A video signal must be present in order to access the **COLOR SETUP** menu.

General Operation - Main Menu



Main Menu Access

There are two methods to access the MAIN menu:

- Press **MENU** button on the remote control.
- Touch **MENU** or the upper left corner of the touch screen from any mode.

Touch Access Buttons

- 1) Touch to access **AM/FM TUNER** mode.
- 2) Touch to access **CD/DVD** mode (CD/DVD must be inserted).
- 3) Touch to access **iPod** mode (optional iPod must be connected to activate).
- 4) Current time is displayed.
- 5) Touch to access **AUXILIARY A/V2 INPUT** mode.
- 6) Touch to access **AUXILIARY A/V1 INPUT** mode.
- 7) Touch to access **USB** mode (optional USB flash drive must be inserted).
- 8) Touch to access **CAMERA** mode (optional camera must be connected).
Note: If optional camera isn't connected, "No Signal Detected" will be displayed.
- 9) Touch to access **SCREEN SETUP** menu.
- 10) Touch to access **MAIN SETUP** menu.

Main Setup - Menu

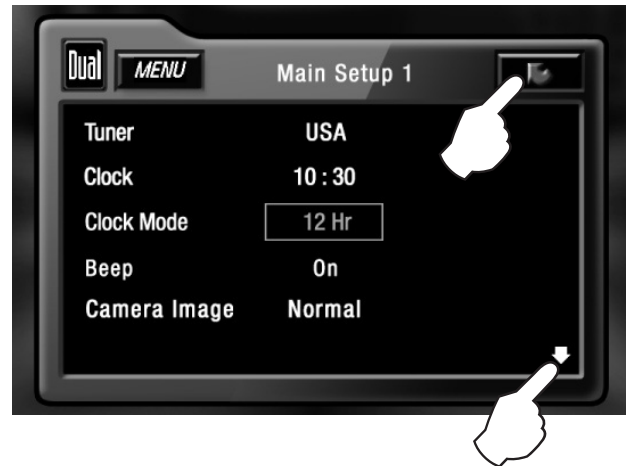

Main Setup Menu Page 1

- Press **MAIN SETUP** icon to access the Main setup mode.
- Select desired parameter you wish to change.
- Page will return back to previous screen after 15 seconds of inactivity or by pressing the **RETURN** arrow in the top right corner.
- Press the **PAGE DOWN** icon to access Main Setup page 2.

MAIN Setup Menu matrix - page 1

Settings	Default	Options	Function
Tuner	USA	USA	Select appropriate tuner frequency spacing for your area
		S-Amer1	
		S-Amer2	
		Europe	
Clock	00:00	00:00	See adjusting the clock on page 21 for more details
Clock Mode	12Hr	12Hr	3:32 (example of 12 hour time setting)
		24Hr	15:32 (example of 24 hour time setting)
Beep	Off	Off	Disables confirmation beep
		On	Enables confirmation beep
Camera Image	Normal	Normal	Normal Image
		Reverse	Mirror camera input image 180 degrees

Main Setup - Menu

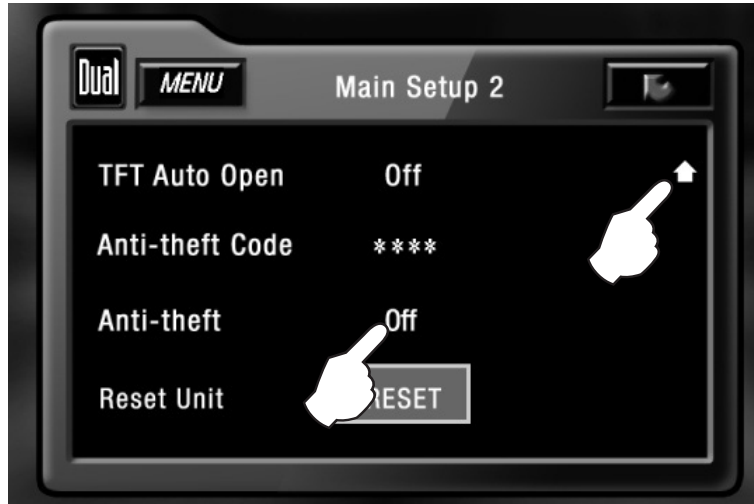

Main Setup Menu Page 2

- Press **MAIN SETUP** icon to access the Main setup mode.
- Press the **PAGE DOWN** icon to access Main Setup page 2.
- Select desired parameter you wish to change.
- Page will return back to previous screen after 15 seconds of inactivity or by pressing the **RETURN** arrow in the top right corner.
- Press the **PAGE UP** icon to access Main Setup page 1.

MAIN Setup Menu matrix - page 2

Settings	Default	Options	Function
TFT Auto Open	Off	On	TFT panel will automatically open when ACC is turned on
		Off	TFT panel will not auto open when ACC is turned on
		Manual	TFT will only open/close when OPEN button is pressed
Anti-theft Code	0000	----	Must enter password to turn anti-theft on or off
Anti-theft	Off	On	System will require a password if main battery power is removed
		Off	No password will be required if main battery power is removed
Reset Unit	Yes	Are you sure? Yes/No	Load all factory parameters to their original settlings Notes: This will not reset the anti-theft password Default anti-theft password is 0000

Main Setup - Adjusting Radio Frequency

Adjusting Radio Frequency

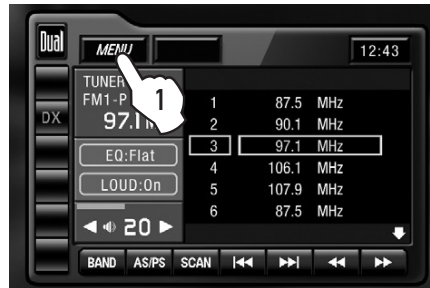

Step 1 Touch **MENU** at the top left corner of screen.



Step 2 Touch **MAIN SETUP** icon.

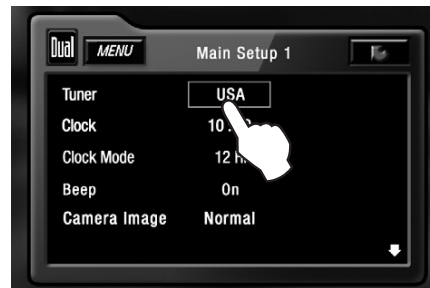

Step 3 Touch **USA**.



Step 4 Touch the setting for your region.

Step 5 Touch **RETURN** to exit.

Main Setup - Adjusting the Clock

12Hr Clock Mode

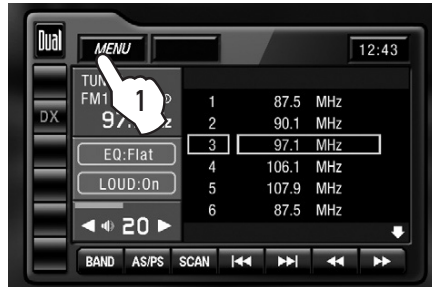

Step 1 Touch **MENU** at the top left corner of screen.



Step 2 Touch **MAIN SETUP** icon.

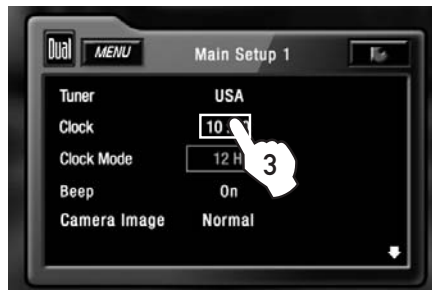

Step 3 3) Touch 00:00 area in the **CLOCK** row.

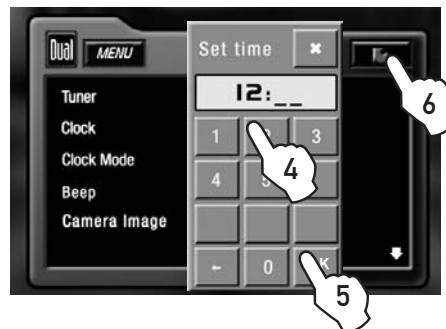

Steps 4-6 4) When keypad appears, enter **HOURS**, followed by **MINUTES**.
5) When finished, touch **OK**.
6) Touch **RETURN** to exit.

For 24Hr format, select 24Hr from **CLOCK MODE**, then follow steps 1-6.

Main Setup - Setting the Anti-theft code

The default Anti-theft password is 0000 and is turned off by default. To turn this feature on, follow the steps below.
CAUTION!! This will lock your unit from operating if battery power is disconnected.

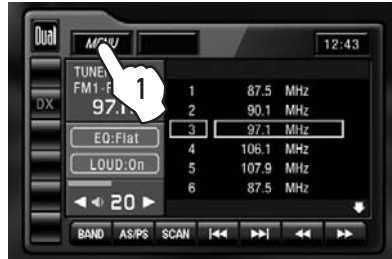

Step 1 & 2 1) Touch MENU.



2) Touch MAIN SETUP icon.



Step 3 & 4 3) Touch down arrow icon.

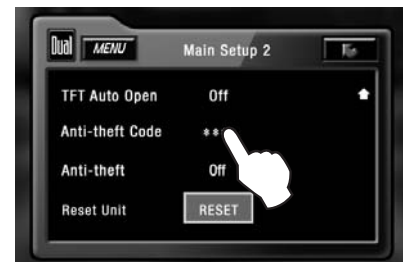

4) Touch ****.



Step 5 & 6 5) Enter 0000, then press OK.



6) Set new 4-digit password, then press OK.



Step 7 & 8 7) Touch Off.



8) Touch On.

Note:
 It is recommended that you choose your own 4-digit password carefully, write it down somewhere and keep in a safe location. In the event you ever lose or forget your password, call our technical support hot-line at 1-866-382-5476 for support in unlocking the system.



Step 9 & 10 9) Enter new 4-digit password (created in step 6), then press OK.
 10) Touch RETURN to exit.

Screen Setup - Menu

Screen Setup Menu



- From the main menu, press **SCREEN SETUP** icon to access the **SCREEN** setup mode.
- Select desired parameter you wish to change.
- Page will return back to previous screen after 15 seconds of inactivity or by pressing the **RETURN** button.

SCREEN Setup Menu matrix

Settings	Default	Options	Function
Brightness	10 (OSD)	0 - 20 (OSD)	Press ◀ or ▶ on the remote, then press ENTER to adjust the Brightness to the desired setting. Brightness can also be adjusted using the Brightness + and - buttons.
Screen Tilt	1	1 - 4	Select 1 to 4 to adjust the default tilt angle of the screen
TS Calibrate		Calibration	Touch Calibration to enter the Touch Screen calibration mode
Version			Software version of unit

Screen Setup - Setting TFT Brightness

This will set the default setting for the TFT display brightness. This can also be set by pressing the INFO button on the front TFT panel for more than 3 seconds, then turning the rotary to adjust brightness level.

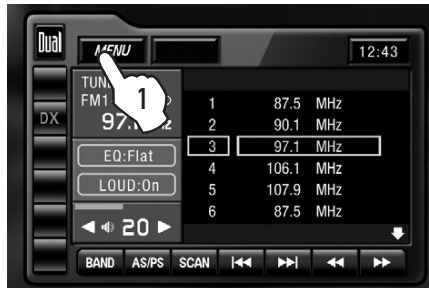

Step 1 1) Touch **MENU** at the top left corner of screen.



Step 2 2) Touch **SCREEN SETUP** icon.

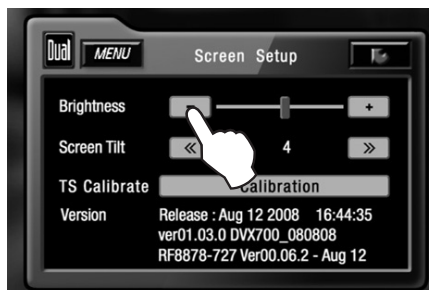

Step 3 3) Touch [-] to reduce brightness.

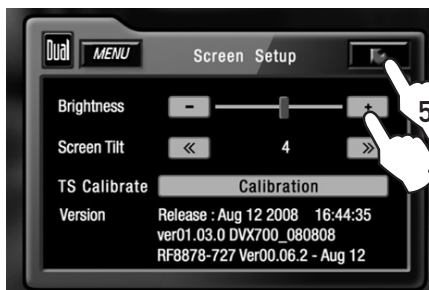

Step 4 4) Touch [+] to increase brightness.

0 - 20 is possible
Default = 10

Step 5 5) Touch **RETURN** to exit.

Screen Setup - Setting TFT Angle

Set for best viewing angle for your vehicle

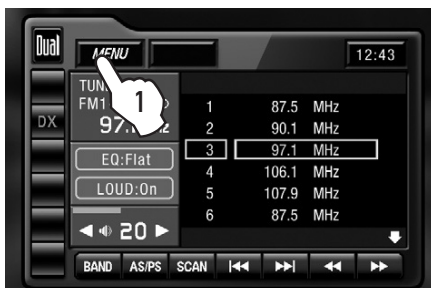

Step 1 1) Touch **MENU** at the top left corner of screen.



Step 2 2) Touch **SCREEN SETUP** icon.

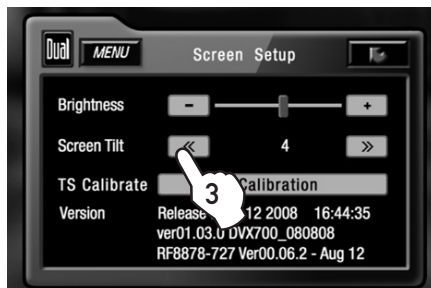

Step 3 3) Touch << to decrease the screen angle.

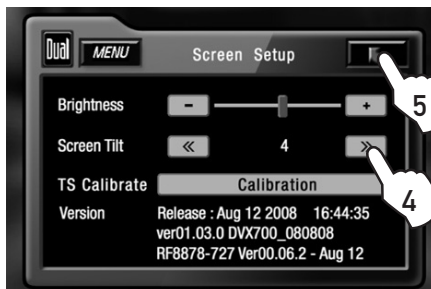

Step 4 4) Touch >> to increase the screen angle.

1 - 4 is possible
Default = 1

Step 5 5) Touch **RETURN** to exit.

Screen Setup - Touch Screen Calibration

Upon initial installation or occasionally, the touch screen may have to be calibrated. Follow these steps as described.

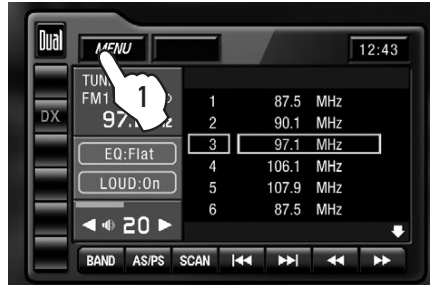

Step 1 1) Touch **MENU** at the top left corner of screen.



Step 2 2) Touch **SCREEN SETUP** icon.

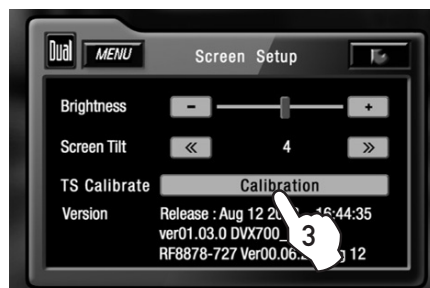

Step 3 & 4 3) Touch **Calibration** in TS Calibrate row.

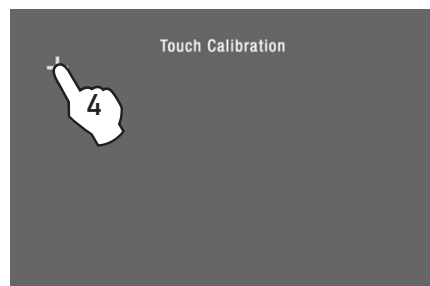

Step 4 & 5 4) Touch the pointers as indicated on the screen.
5) Screen will automatically return to **MAIN MENU** when the calibration procedure is complete.

AM/FM Tuner Operation - OSD Overview

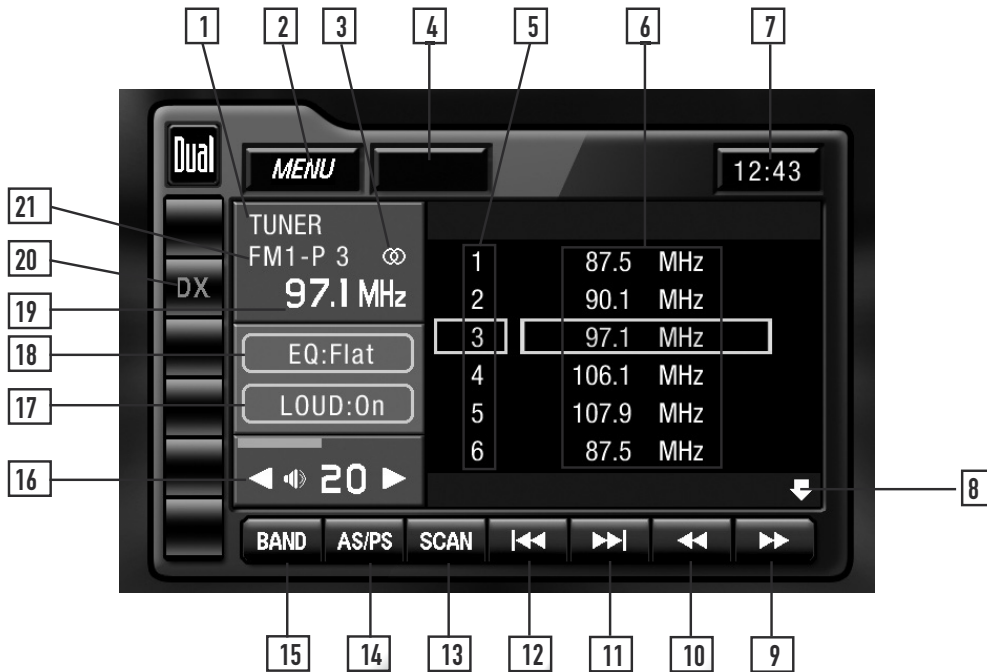

Tuner Mode

From the main menu, touch TUNER icon on the screen to select AM/FM Tuner mode.

- 1** Current Source Indicator
Displays source currently playing.
- 2** Main Menu
Touch **MENU** to access the main menu.
- 3** Stereo Indicator
Shows that the frequency selected is received in stereo.
- 4** Information Indicator
Displays status of various tuning functions including Auto Station Store, Preset Scan, Scan tuning, etc.
- 5** Preset Number List Display
Shows the preset list by preset number. Touch preset number to select a preset. Touch and hold preset number to store presets.
- 6** Preset Station List Display
Shows the preset station list by frequency. Touch frequency to select a preset. Touch and hold frequency to store presets.
- 7** Clock Indicator
Shows current time.
- 8** Preset List Page - Up/Down
Touch Page Up/Down arrows to select the next or previous page.



AM/FM Tuner Operation - OSD Overview

- | | |
|----|--|
| 9 | <p>Tune Frequency - Up
Touching this icon will tune the radio to a higher frequency by one frequency step. Touch and hold for continuous tuning up. (This function can also be performed by pressing the corresponding key on the remote control.)</p> |
| 10 | <p>Tune Frequency - Down
Touching this icon will tune the radio to a lower frequency by one frequency step. Touch and hold for continuous tuning down. (This function can also be performed by pressing the corresponding key on the remote control.)</p> |
| 11 | <p>Seek Next Station - Up
Touching this icon will tune to the next strong station at a higher frequency. (This function can also be performed by pressing the corresponding key on the front panel or remote control.)</p> |
| 12 | <p>Seek Next Station - Down
Touching this icon will tune to the next strong station at a lower frequency. (This function can also be performed by pressing the corresponding key on the front panel or remote control.)</p> |
| 13 | <p>Tuner Scan
Touch this icon to scan through all available stations in the current band. Touch again to disable.</p> |
| 14 | <p>Preset Scan/Auto Station Tune
Touching this icon will scan through all presets in the current band. Holding this button for more than 2 seconds will automatically program the 12 strongest stations available into the presets in the current band.</p> |
| 15 | <p>Band
Touch band icon repeatedly until the desired band is displayed, FM1, FM2 or AM. (This function can also be performed by pressing BAND button.)</p> |
| 16 | <p>Volume Indicator
Indicates current volume level, controlled by rotary encoder.</p> |
| 17 | <p>Loudness Indicator
Touch screen here to turn the Loudness function on/off.</p> |
| 18 | <p>EQ Indicator
Touch screen here to enter Audio Setup Menu.</p> |
| 19 | <p>Current Station Indicator
Indicates current frequency.</p> |
| 20 | <p>Local / DX Tuning Mode
Shows when local or distance tuning is on.</p> |
| 21 | <p>Band Indicator
Shows which band the radio is tuned to, FM1, FM2 or AM.</p> |

AM/FM Tuner Operation



AM/FM Tuner Mode	From the main menu, touch TUNER icon to select AM/FM Tuner mode.
	From the remote control or the front panel: Press MODE until the current station information is displayed on the screen.
Band	Touch BAND on the screen repeatedly until the desired band is displayed, FM1, FM2 or AM.
	Press the BAND button on the front panel to switch between bands, FM1, FM2 or AM.
	From the remote control: Press the BAND button.
Manual Tuning	Touch ▶▶ on the screen to tune to the next higher frequency step.
	Touch ◀◀ on the screen to tune to the next lower frequency step.
	Touch and hold either ◀◀ or ▶▶ on the screen to continue tuning across multiple stations.
	From the remote control: Touch ◀◀ or ▶▶ to perform manual tuning.
Seek Tuning	Touch ▶▶ to tune to the next higher strong station.
	Touch ◀◀ to tune to the next lower strong station.
	From the remote control: Press ▶▶ to tune to the next higher strong station. Press ◀◀ to tune to the next lower strong station.
Storing Presets	There are 24 FM and 12 AM presets available in 3 bands.
	After finding the desired frequency to store in memory, touch and hold the screen on any of the frequencies or preset numbers in the preset station list until it turns yellow. The new station will replace the previous selection.
Auto Store Presets	Touch and hold AS/PS to automatically program the 12 strongest stations available into the presets in the current band.
Preset Scan	Touch AS/PS to scan through all tunable presets in the current band and play them for 10 seconds each.



AM/FM Tuner Operation

Direct Preset Tuning

To select a desired station from the preset station list, touch any of the displayed station frequencies or preset numbers from the list. Use the up and down arrows on screen to select between the preset pages, if necessary.

From the remote control:

Press ▲ or ▼ to scroll through the presets. When the correct preset is highlighted press **OK**.

Scan Tuning

Touch **SCAN** on the screen and it will tune you to all stations available with good reception for 10 seconds at a time. Touch **SCAN** again to disable.

Local/Distance Tuning

Local tuning lets you tune in radio stations with sufficiently strong signals for good reception. In areas that reception is poor, you can switch from local to distance tuning by touching the **LOC** button on the screen. To return to distance tuning mode, press the **LOC** button again. (Distance tuning is the default tuning mode.)



⚠ WARNING ⚠

Upon installation of this Monitor/DVD player (“unit”) into a vehicle, the driver of the vehicle must not operate this unit by watching videos or playing video games while driving. Failure to follow this instruction could lead to driver distraction which could result in serious injury or death to the vehicle’s occupants or persons outside the vehicle and/or property damage.

Several states prohibit the installation of monitors/DVD players if the screen is visible from the driver’s seat. If you reside in a jurisdiction which has enacted such a law, this unit must not be installed so that the screen is visible from the driver’s seat. When installing this unit in the front console/dashboard, the unit must be positioned so that it is facing the front passenger seat only. Failure to follow this instruction could lead to driver distraction which could result in serious injury or death to the vehicle’s occupants or persons outside the vehicle and/or property damage.

This unit is designed so that it may be operated only when the vehicle is in “Park” and the parking brake is fully engaged. To this end, this unit includes a parking brake lock-out feature which prohibits the unit from operating if the vehicle is not in “Park” and/or the parking brake is not fully engaged. When installing this unit, the installer must connect the parking brake detect wire (“Yellow-Blue Lead”) to the parking brake mechanism in order to make the parking brake lock-out feature operable. DO NOT simply ground the parking brake detect wire to a metal portion of the vehicle. Failure to properly install the parking brake lock-out feature could lead to driver distraction which could result in serious injury or death to the driver’s occupants or persons outside the vehicle and/or property damage.

Once the parking brake lock-out feature is installed, the owner/user must not attempt to disrupt/neutralize the parking brake lock-out feature by (a) partially engaging the parking brake and/or (b) purchasing/using any device or unit designed to send necessary brake signals to the unit. Failure to follow these instructions could lead to driver distraction which could result in serious injury or death to the driver’s occupants or persons outside the vehicle and/or property damage.

When operating this unit, keep the unit’s volume level low enough so that the vehicle’s occupants can hear traffic-related sounds such as police and emergency vehicles. Failure to follow this instruction could lead to driver distraction which could result in serious injury or death to the vehicle’s occupants or persons outside the vehicle and/or property damage.

DVD Setup - Parking Brake Initialization



CAUTION !!!
IT'S UNLAWFUL TO OPERATE
A VEHICLE WHILE VIDEO IS
DISPLAY IN THE DRIVERS
VIEWING AREA

ENGAGE EMERGENCY BRAKE
TO WATCH VIDEO

Front Monitor Video Initialization

Parking Brake Initialization Situation 1

Parking Brake Initialization Situation 2

SAFETY WARNING

- The video display of the in-dash unit will not operate while the vehicle is moving. This is a safety feature to prevent driver distraction. In-dash video functions will only operate when vehicle is in Park and the **PARKING BRAKE** is engaged. It is illegal in most states for the driver to view video while the vehicle is in motion. Refer to local laws in your area.
- The vehicle must be in park and the parking brake applied to view video on the in-dash monitor.
- As a safety feature, **!!Safety Warning!!** blue screen will show on the display when the vehicle's parking brake is not engaged. Video display on the front monitor isn't allowed until the **PARKING BRAKE** is engaged. Connect the yellow/blue **PARKING BRAKE** wire to the brake switch circuit as described on page 6. **Note:** DVD and AUX AV audio can be heard while the vehicle is in motion without engaging the parking brake.

Follow these two initialization procedures carefully to allow video playback on on the XDVD9101 front monitor:

There are two situations to initiate the **PARKING BRAKE** sequence.

First situation (if vehicle is moving):

- 1) Stop vehicle, put in Park, make sure **PARKING BRAKE** is off/released.
- 2) Depress **PARKING BRAKE** for 1 second.
- 3) Release **PARKING BRAKE** for 1 second.
- 4) Depress **PARKING BRAKE** permanently.

Note:

Once above procedure 1-4 is completed, video will display in about 2 seconds.

Second situation (if vehicle is already parked and the **PARKING BRAKE** is already applied):

- 1) Keep vehicle in Park, **PARKING BRAKE** should be on.
- 2) Release **PARKING BRAKE** for 1 second.
- 3) Depress **PARKING BRAKE** for 1 second.
- 4) Release **PARKING BRAKE** for 1 second.
- 5) Depress **PARKING BRAKE** permanently.

Notes:

Once above procedure 1-5 is completed, video will display in about 2 seconds. The transition time must be less than 2 seconds between depress and release. This procedure must be repeated anytime the vehicle ignition is turned off.



DVD Setup - Region Management



DVD Region Management

Some DVD discs can be played only in certain playback modes according to the intentions of the software. As the XDVD9101 plays discs according to their intentions, some functions may not work as intended. Please be sure to read the instructions provided with each disc. This player has been designed to play back DVD software that has been encoded for specific region areas. It cannot play back DVD software encoded for other region areas than the region areas for which it has been designed.

The XDVD9101 will play discs labeled "Region 1" or "All".

DVD region codes:

- 1 - USA, Canada
- 2 - Japan, Europe, South Africa, Middle East
- 3 - Rep. of Korea, Taiwan, Hong Kong, Parts of Southeast Asia
- 4 - Australia, New Zealand, Mexico, South America
- 5 - Eastern Europe, Russia, India, Africa
- 6 - China



DVD Disc Symbols

Symbol	12cm Disc Properties	Max Play Time
	Single side single layer (DVD-5) Single side double layer (DVD-9) Double side single layer (DVD-10) Double side double layer (DVD-18)	(MPEG 2 Method) 133 minutes 242 minutes 266 minutes 484 minutes
	Single side single layer (VCD)	(MPEG 1 Method) 74 minutes
	Single side single layer	74 minutes

Symbol	Meaning
	Number of voice languages recorded. The number inside the icon indicates the number languages on the disc (maximum of 8).
	Number of subtitle languages available on the disc (maximum of 32).
	Number of angles provided (maximum of 9).
	Aspect ratios available. "LB" stands for Letter Box and "PS" stands for Pan/Scan. In the example on the left, the 16:9 video can be converted to Letter Box video.
	Indicates the region code where the disc can be played. <ul style="list-style-type: none"> · Region 1: USA, Canada, East Pacific Ocean Islands · Region 2: Japan, Western Europe, Northern Europe, Egypt, South Africa, Middle East · Region 3: Taiwan, Hong Kong, South Korea, Thailand, Indonesia, South-East Asia · Region 4: Australia, New Zealand, Middle and South America, South Pacific Ocean Islands/ Oceania · Region 5: Russia, Mongolia, India, Middle Asia, Eastern Europe, North Korea, North Africa, North-West Asia

Notes:

Some DVD discs can be played only in certain playback modes according to the intentions of the software. As the XDVD9101 plays discs according to their intentions, some functions may not work as intended. Please be sure to read the instructions provided with each disc.



DVD Setup - Inserting a Disc



Insert DVD with label facing upwards

Inserting a Disc

With the label facing up, insert a standard size disc into the slot. The disc will automatically begin playback. Other sub-menus may have to be pressed to access the DVD movie/music content. Read the directions of your specific DVD disc for other features.

Note: If PARENTAL Lock is activated and the disc inserted is not authorized, a 4-digit code must be entered and/or the disc be authorized. See "RATING MENU" on page 38.

Note: Only one disc can be inserted at a time.

Ejecting the Disc

Press the EJECT button.

Resetting the Loading Mechanism

If the disc loads abnormally or an system error occurs, press and hold the eject button for 3 seconds to reset the loading mechanism. The disc will eject and normal operation should resume.

DVD Setup - Touch Screen Controls



Hidden Touch Screen areas while in DVD mode

There are several hidden TOUCH SCREEN areas as outlined below:

"A" area can be used in DVD, AUX 1 and AUX 2 modes to access MAIN menu.

Using the hidden Touch Screen Controls

- A - Displays MAIN menu
- B - Displays DVD disc information
- C - Selects PREVIOUS chapter
- D - Selects NEXT chapter
- E - Displays the DVD transport controls
- F - Displays search menu

Note:
A DVD disc must be inserted to access these functions and features.

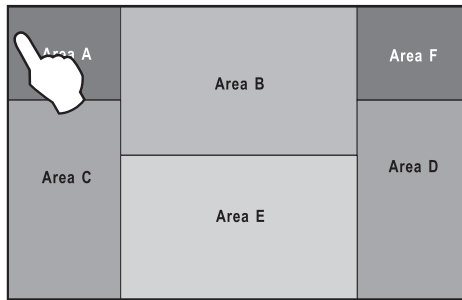

AREA A
Access MAIN Menu

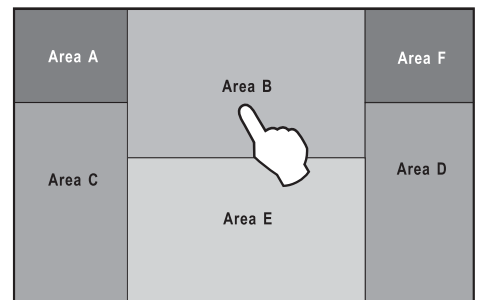

AREA B
Displays Disc Information

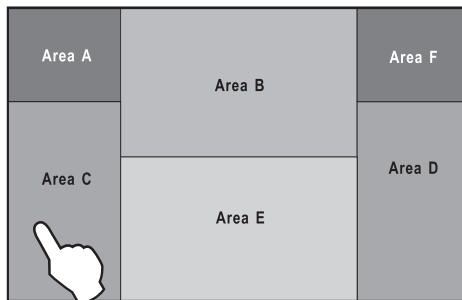

AREA C
Selects PREVIOUS Chapter

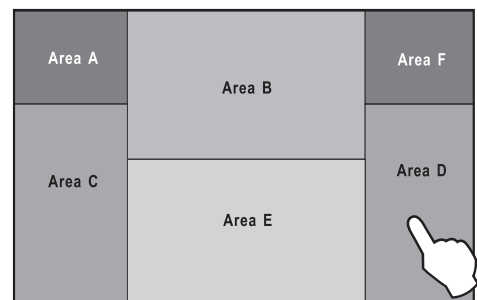

AREA D
Selects NEXT Chapter

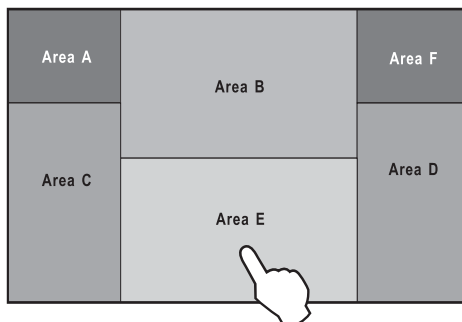

AREA E
Displays DVD Transport Controls

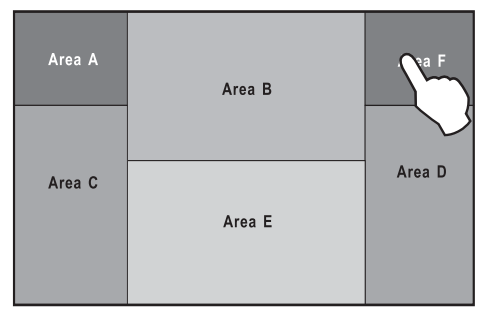

AREA F
DVD Search



LANGUAGE Setup Menu

Note:
A DVD disc must be inserted to access these functions and features.

DVD Setup Menu - Language

With the unit in DVD mode, press AREA E (bottom center of screen) to display the DVD transport controls (1). Press **Setup** (2) or press and hold the 0 key on the remote to access the DVD setup menu. The LANGUAGE setup menu will automatically be displayed.



Sub Title Press the current selection to select desired disc subtitle language.



English
French
Spanish
Auto
Off = DEFAULT

DVD Audio Press the current selection to select desired disc audio language.



English = DEFAULT
French
Spanish

DVD Menu Press the current selection to select desired disc menu language.



English = DEFAULT
French
Spanish

DVD Setup Menu - Video Settings



Video Setup Menu

Note:
A DVD disc must be inserted to access these functions and features.

With the unit in DVD mode, press AREA E (bottom center of screen) to display the DVD transport controls (1). Press **Setup** (2) or press and hold the 0 key on the remote to access the DVD setup menu. The LANGUAGE setup menu will automatically be displayed. Press the VIDEO icon (3) to display the VIDEO setup menu.

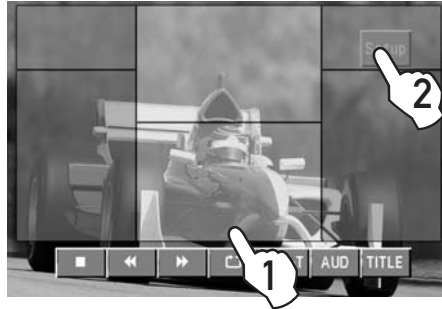

TV Shape

Press to select desired TV shape.



Normal/PS
Normal/LB
Wide



Angle Mark

Select On to activate angle mark.



On
Off





DVD Setup Menu - Rating

Rating Setup Menu

Note:
A DVD disc must be inserted to access these functions and features.

With the unit in DVD mode, press AREA E (bottom center of screen) to display the DVD transport controls (1). Press **Setup** (2) or press and hold the 0 key on the remote to access the DVD setup menu. The LANGUAGE setup menu will automatically be displayed. Press the RATING icon (3) to display the RATING setup menu.

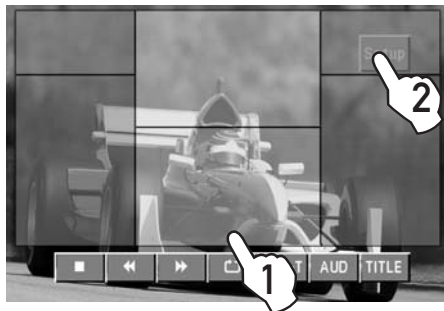

Enable Parental Lock Password

Touch the current rating, select desired rating, then input password. Default password is "0000".



Setting Parental Lock Password

1. Touch ****, enter current password, then press OK.
2. Enter new password, then press OK.

Rating Setting

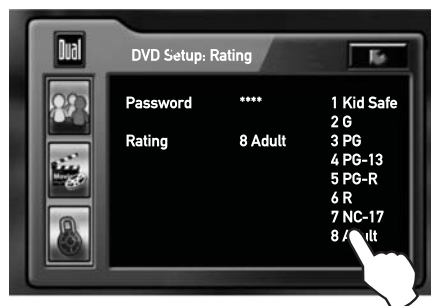

1. Kid Safe
2. G
3. PG
4. PG-13
5. PG-R
6. R
7. NC-17
8. Adult = DEFAULT

Parental Password Override

In the event you forget or lose your PARENTAL LOCK password, enter 9991.

DVD Operation - Touch Screen Controls



Using the hidden Touch Screen Controls

Touch AREA E



DVD Mode

From the main menu, touch the DISC icon on the screen to select DVD mode.

- 1

Setup Menu
 Accesses the DVD Setup menu
- 2

Stop
 Touch the ■ icon to stop the chapter where it is. Touch again to stop the disc (full stop).
- 3

Fast Reverse
 Touch the ◀◀ icon to fast reverse at 2x speed. Each touch changes speed from 2x to 4x to 8x to 16x to 32x, then back to 1x play.
- 4

Fast Forward
 Touch the ▶▶ icon to fast forward at 2x speed. Each touch changes speed from 2x to 4x to 8x to 16x to 32x, then back to 1x play.
- 5

Repeat
 Touch the ↺ icon to repeat the current chapter or title.
- 6

Sub-Title Mode
 Activates sub-titles and cycles between multiple sub-title languages.
- 7

Audio Mode
 Touch this icon to activate alternate audio modes on DVD's that have alternate audio streams.
- 8

Title Menu
 Accesses the DVD Title menu.



DVD Operation - Searching a DVD

Searching a DVD

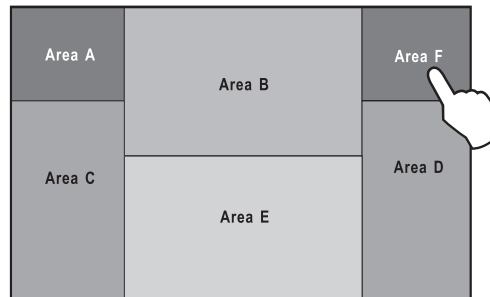

Searching by Time, Title or Chapter

Touch Area F to bring up the Search keypad, which allows a search for a specific time, title or chapter. The Time search window appears as the default. Press Time to toggle to the Title/Chapter search window.



Time Search

Once the Time search window is open, use the keyboard to enter a specific time on the disc, then touch **OK**. For example, to skip to 1 hour, 12 minutes and 19 seconds into the DVD, touch **0 1, 1 2, 1 9, OK**.

Title/Chapter Search

Once the Title/Chapter search window is open, use the keypad to enter a specific title and/or chapter on the disc, then touch **OK**. This can be used to select a specific chapter in the current title, a new title or a specific chapter in a new title.



From the remote control:
 Press **SRCH** once to access Time. Press **SRCH** again to access Title/Chapter. Use the arrows to highlight either the time, title or chapter field and use the numeric keypad to enter the appropriate information and press **OK**.

Note:

Some DVD discs can be played only in certain playback modes according to the intentions of the software. As the XDVD9101 plays discs according to their intentions, some functions may not work as intended. Please be sure to read the instructions provided with each disc.

DVD Operation



Playback Control	<p>Touch Area E to bring up the on-screen buttons. Touch ►► to fast forward or ◀◀ to fast reverse. Each subsequent press of the button will change the speed from normal to 2x to 4x to 8x to 16x to 32x and back to 1x.</p> <p>From the front panel: Press and hold ►► to fast forward. Press and hold ◀◀ to fast reverse.</p> <p>From the remote control: Press ►► to fast forward. Press ◀◀ to fast reverse.</p>
Repeat Mode	<p>Touch the ↺ icon to repeat either a chapter or title. The first touch activates Repeat Chapter mode and a second touch activates Repeat Title mode. Press a third time to turn Repeat Off.</p> <p>From the remote control: Press ↺ to select Repeat Chapter, Repeat Title and Repeat Off modes.</p> <p>Note: The Repeat Mode can only be changed while the DVD is playing.</p>
Play/Pause	<p>Touch PLAY/PAUSE on the front panel to temporarily stop playback of the DVD. Touching it again will resume playback.</p> <p>From the remote control: Press PLAY to temporarily stop and resume playback.</p>
Stop	<p>Touch ■ to stop playback. Pressing PLAY at this point will resume playback. If ■ is touched a second time, then playback stops completely and will restart from the beginning of the disc.</p> <p>From the remote control: Press ■ to stop playback.</p>
Sub-Titles	<p>Touch the SUB-T icon to activate Sub-Title mode and select a sub-title language. Each touch will cycle the mode from off to language 1, language 2, etc., and back to off.</p> <p>From the remote control: Press the SUB-T button to control Sub-Title mode.</p> <p>Notes:</p> <ul style="list-style-type: none">• Not all DVD's have sub-titles and when they do, some will only have 1 language. Therefore this function may be disabled or limited.• The Sub-Title Mode can only be changed while the DVD is playing.



DVD Operation

DVD Audio Touch **AUD** to change the audio stream. Each touch will cycle the language.

From the remote control:

Press the **AUDIO** button to select the **Audio** stream.

Notes:

- Not all DVD's have multiple languages, therefore this function may be disabled or limited.
- The **Audio** stream can only be changed while the DVD is playing.

DVD Disc Information Touch Area B or press **INFO** to bring up the **DVD Disc Information**, which includes: Current/Total Titles (1) and Chapters (5), elapsed time for current title (2), EQ Mode (3) and Loudness setting (6) and current time (4).

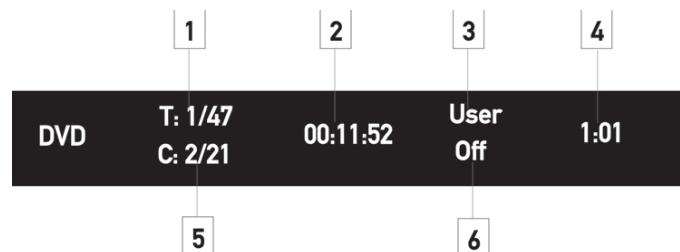

From the remote control:

Press the **INFO** button to bring up the **DVD Disc Information**.

Zoom Mode From the remote control:
Press the **ZOOM** button to activate **Zoom Mode**.

Each subsequent press of the button will change the magnification from normal to 1x to 2x to 3x to 4x then to 1/2x, 1/3x, 1/4x and back to normal.

When **Zoom Mode** is active in 2x, 3x or 4x, the arrows on the remote will pan the screen up, down, right and left.

DVD Title Menu Touch the Title Menu icon to return to the DVD main menu.

From the remote control:

Press **TITLE** to return to the DVD main menu.

Press **ROOT** to move up one level on the DVD menus. (For example, when viewing bonus materials, the **ROOT** button will return to the bonus menu instead of the main menu.) Pressing **ROOT** again will usually return to the current chapter.

Note: On some DVD's the **TITLE** and **ROOT** functions may be reversed.



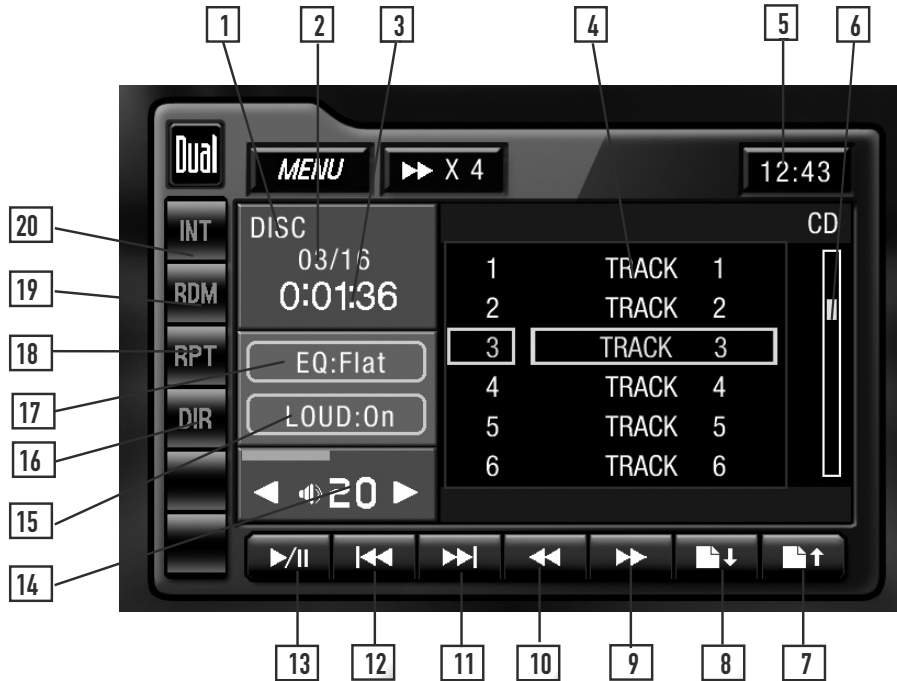





CD Operation - OSD Overview



CD Mode	
1	Current Source Indicator Displays source currently playing.
2	Track Number Indicator Displays current track number and total number of tracks on the disc.
3	Track Time Indicator Shows the elapsed time of the current track.
4	Track Title List Displays up to 6 tracks on the disc in order, with track number.
5	Clock Displays the current time.
6	Scroll bar Indicates position of current track relative to the disc.
7	Page Up Touch the  icon to see the previous 6 tracks on the disc.



CD Operation - OSD Overview

- | | |
|----|---|
| 8 | Page Down
Touch the  icon to see the next 6 tracks on the disc. |
| 9 | Fast Forward
Touch the  icon to fast forward at 2x speed. Each touch changes speed from 2x to 4x to 8x to 16x to 32x then to 1x play. |
| 10 | Fast Reverse
Touch the  icon to fast reverse at 2x speed. Each touch changes speed from 2x to 4x to 8x to 16x to 32x then to 1x play. |
| 11 | Track Up
Touch  to skip ahead to the next track. |
| 12 | Track Down
Touch  once to return to the beginning of the current track. Press again to return to the previous track. |
| 13 | Play/Pause
Touch the  icon to temporarily stop or resume playback. |
| 14 | Volume Adjustment
Indicates current volume level. Turn the rotary or use the volume  or  on screen to adjust the volume level lower or higher (0-46). |
| 15 | Loudness Indicator
Touch LOUD to turn the Loudness feature On or Off. |
| 16 | Direct Select Keyboard
Touch DIR to display a numeric keyboard. Enter desired track number and touch OK to select it. |
| 17 | EQ Indicator
Touch screen here to enter Audio Setup Menu. |
| 18 | Repeat
Touch RPT to repeat current track. Rpt Trk will appear next to the MENU button while this feature is activated. Touch RPT again to exit Repeat mode. |
| 19 | Random
Touch RDM to shuffle all tracks on the disc. Random will appear next to the MENU button while this feature is activated. Touch RDM again to exit Random mode. |
| 20 | Intro
Touch INT to listen to 10 seconds of each track in order. Intro will appear next to the MENU button while this feature is activated. Touch INT again to exit Intro mode. |

CD Operation



Navigating the Track Title List

Navigate the track title list in one of two ways:

- Using the Page Up and Page Down buttons on the screen.
- Using the arrow buttons on the remote control.

Track Select

To select a desired track from the track title list, touch any track on the list.

From the remote control:

Press ▲ or ▼ to scroll through the tracks. When the correct track is highlighted press OK.

Direct Select

To navigate forwards or backwards through all tracks, press ◀◀ or ▶▶ on the screen, front panel or remote control:

Press ▶▶ to skip to the next track.

Press ◀◀ to skip to the previous track.

Note: Pressing ◀◀ once will return to the beginning of the current track.

Pressing it a second time will skip to the previous track.

Direct Track Entry

Touch **DIR** to display a numeric keyboard. Enter desired track number, and touch **OK** to select it.

From the remote control:

Use the numeric keypad to enter the desired track number.

Fast Forward/Fast Reverse

Use the Fast Forward or Fast Reverse on-screen buttons to speed up the playback of a track. Each subsequent press of the button will change the speed from normal to 2x to 4x to 8x to 16x to 32x and back to 1x.

Press ▶▶ to fast forward.

Press ◀◀ to fast reverse.

From the remote control:

Press ▶▶ to fast forward.

Press ◀◀ to fast reverse.

Intro Mode



Touch **INT** on the screen to listen to all tracks on the CD for 10 seconds at a time, starting from the first track on the CD. **Intro** will appear next to the **MENU** button while this feature is activated. Touch **INT** again to exit Intro Mode.

Random Mode

Touch **RDM** to shuffle all of the tracks on the CD. **Random** will appear next to the **MENU** button while this feature is activated. Touch **RDM** again to exit Random Mode.



CD Operation

Repeat Mode	<p>Touch RPT to repeat a track. Rpt Trk will appear next to the MENU button while this feature is activated. Touch RPT again to exit Random Mode.</p> <p>From the remote control: Press  to select Repeat. Press it a second time to disable Repeat.</p> <p>Note: Shuffle and Repeat modes can not be used simultaneously and engaging one mode will cancel the other mode (if active.)</p>
Repeat A-B	<p>From the remote control: Press A → B button once to select a start point. Press it a second time to select and end point. RPT: A-B will appear next to the MENU button. The loop will play from the start point to the end point until A → B is pressed again.</p>
Play/Pause	<p>Press PLAY/PAUSE to temporarily stop playback of the current track. Touching it again will resume playback.</p> <p>From the remote control: Press PLAY to temporarily stop and resume playback.</p>
Stop	<p>Press BAND to stop playback of the current song. Pressing PLAY at this point will resume playback. Press BAND a second time to stop playback completely. Play will restart from the beginning of the disc.</p> <p>From the remote control: Press  on the remote control to stop playback of the current song. Pressing PLAY at this point will resume playback. If  is touched a second time, playback stops completely and will restart from the beginning of the CD.</p>

MP3/WMA/JPG Operation - OSD Overview

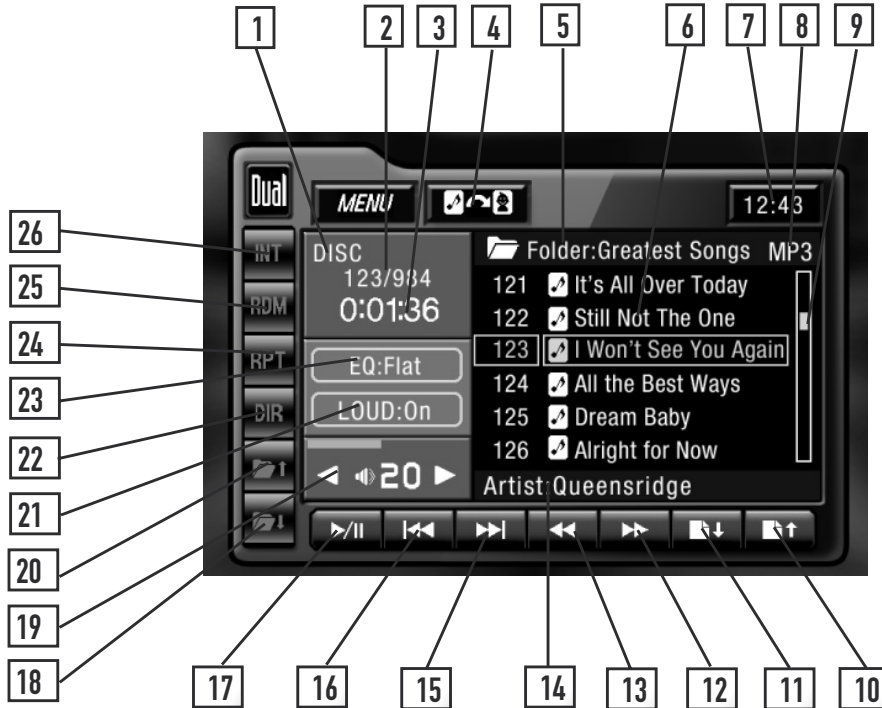











MP3/WMA Mode

From the main menu, touch the **DISC** icon on the screen to select MP3/WMA mode.

- 1** Current Source Indicator
Displays source currently playing.
- 2** File Number Indicator
Displays current file number and total number of files in the current folder.
- 3** Elapsed Time Indicator
Shows the elapsed time of the current song.
- 4** Sound to Image Indicator
Press to switch from viewing sound files to image files.
- 5** Folder Name
Displays the name of the currently selected folder.
- 6** Playlist
Displays up to 6 files in order, with filename.
- 7** Clock
Displays the current time.
- 8** File Type Indicator
Displays type of file, either **MP3**, or **WMA** or **JPG**.
- 9** Scroll bar
Indicates position of current file relative to the current folder.
- 10** Page Up
Touch the  icon to see the previous 6 files in the current folder.



MP3/WMA/JPG Operation - OSD Overview

- | | |
|----|---|
| 11 | <p>Page Down
Touch the  icon to see the next 6 files in the current folder.</p> |
| 12 | <p>Fast Forward
Touch the  icon to fast forward at 2x speed. Each touch changes speed from 2x to 4x to 8x to 16x to 32x then to 1x play.</p> |
| 13 | <p>Fast Reverse
Touch the  icon to fast reverse at 2x speed. Each touch changes speed from 2x to 4x to 8x to 16x to 32x then to 1x play.</p> |
| 14 | <p>Information
Displays available ID3 tag information for the current song.</p> |
| 15 | <p>Track Up
Touch  to skip ahead to the next track.</p> |
| 16 | <p>Track Down
Touch  once to return to the beginning of the current track. Press again to return to the previous track.</p> |
| 17 | <p>Play/Pause
Touch  icon to temporarily stop or resume playback.</p> |
| 18 | <p>Previous Folder
Touch the  icon to select the previous available folder.</p> |
| 19 | <p>Volume Adjustment
Indicates current volume level. Turn the rotary or use the volume  or  on screen to adjust volume level lower or higher (0-46).</p> |
| 20 | <p>Next Folder
Touch the  icon to select the next available folder.</p> |
| 21 | <p>Loudness Indicator
Touch LOUD to turn the Loudness feature On or Off.</p> |
| 22 | <p>Direct Select Keyboard
Press DIR to display a numeric keyboard. Enter desired track number and touch OK to select it.</p> |
| 23 | <p>EQ indicator
Press EQ to enter the Audio Setup Menu.</p> |
| 24 | <p>Repeat
Touch RPT to repeat current track and again to repeat all tracks in the current folder. Touch RPT again to exit Repeat mode.</p> |
| 25 | <p>Random
Touch RDM to shuffle all tracks in the current folder and again to shuffle all tracks on the disc. Touch RDM again to exit Random mode.</p> |
| 26 | <p>Intro
Touch INT to listen to 10 seconds of each track in the current folder and again to preview all tracks on the disc. Touch INT again to exit Intro mode.</p> |

MP3/WMA/JPG Operation



Sound to Image Indicator

The Sound to Image indicator allows the selection of either sound (MP3 or WMA) or image (JPEG) files to be displayed in the Playlist.





Indicates that sound files are currently displayed. Press to switch to viewing image files.





Indicates that image files are currently displayed. Press to switch to viewing sound files.



Folder List

Press the Folder Name area at the top of the screen to display the first six folders on the disc. Press  or  or use the ▲ and ▼ buttons on the remote control to view additional folders.

Navigating the Folder/Playlist

Once a folder is selected, the display will change to show the first six files in that folder. The current folder name will appear in the Folder Name area. Press  to navigate back to the previous folder, or press  to skip forward to the next folder.



File Select

Navigate through the Playlist by pressing  or  on the screen. Once the desired file is highlighted, simply touch the screen at the appropriate file name to begin playback.

From the remote control:

Press ▲ or ▼ to scroll through the files. When the correct file name is highlighted press OK.



Direct Select

To navigate forwards or backwards through all tracks, press  or  on the screen, front panel or remote control:

Press  to skip to the next track.

Press  to skip to the previous track.

Note: Pressing  once will return to the beginning of the current track. Pressing it a second time will skip to the previous track.

Note: Pressing  from the last track in one folder will advance to the first track in the next folder. Pressing  from the first track in a folder will return to the previous folder.

Direct Track Entry

Touch DIR to display a numeric keyboard. Enter desired track number in the current folder, and touch OK to select it.

From the remote control:

Use the numeric keypad to enter the desired track number in the current folder.

Fast Forward/Fast Reverse

Use the Fast Forward or Fast Reverse on-screen buttons to speed up the playback. Each subsequent press of the button will change the speed from normal to 2x to 4x to 8x to 16x to 32x and back to 1x.

Press  to fast forward.

Press  to fast reverse.



MP3/WMA/JPG Operation

Fast Forward/Fast Reverse

From the remote control:
Press ►► to fast forward.
Press ◀◀ to fast reverse.

Intro Mode

Touch **INT** on the screen to listen to all tracks in the current folder for 10 seconds at a time, starting from the next track. **Int Fol** will appear next to the **MENU** button while this feature is activated.

Touch **INT** again to preview all tracks on the disc. **Intro** will appear next to the **MENU** button while this feature is activated. Touch **INT** again to exit Intro Mode.

Random Mode

Touch **RDM** on the screen to shuffle all tracks in the current folder. **Rdm Fol** will appear next to the **MENU** button while this feature is activated.

Touch **RDM** again to shuffle all tracks on the disc. **Rdm All** will appear next to the **MENU** button while this feature is activated. Touch **RDM** again to exit Random Mode.

Repeat Mode

Touch **RPT** to repeat a track and again to repeat all tracks in the current folder. **Rpt Trk** or **Rpt Fol** will appear next to the **MENU** button while this feature is activated. Touch **RDM** again to exit Random Mode.

From the remote control:
Press ◂ to select between Repeat, Folder Repeat and Repeat Off modes.

Note: Shuffle and Repeat modes can not be used simultaneously and engaging one mode will cancel the other mode (if active.)

Repeat A-B

From the remote control:
Press A → B button once to select a start point. Press it a second time to select and end point. **RPT: A-B** will appear next to the **MENU** button. The loop will play from the start point to the end point until A → B is pressed again.

Play/Pause

Press **PLAY/PAUSE** to temporarily stop playback of the current track. Touching it again will resume playback.

From the remote control:
Press **PLAY** to temporarily stop and resume playback.

Stop

Press **BAND** to stop playback of the current track. Pressing **PLAY** at this point will resume playback. Press **BAND** a second time to stop playback completely. Play will restart from the beginning of the disc.

From the remote control:
Press ■ on the remote control to stop playback of the current track. Pressing **PLAY** at this point will resume playback. If ■ is touched a second time, playback stops completely and will restart from the beginning of the disc.

USB Operation - OSD Overview

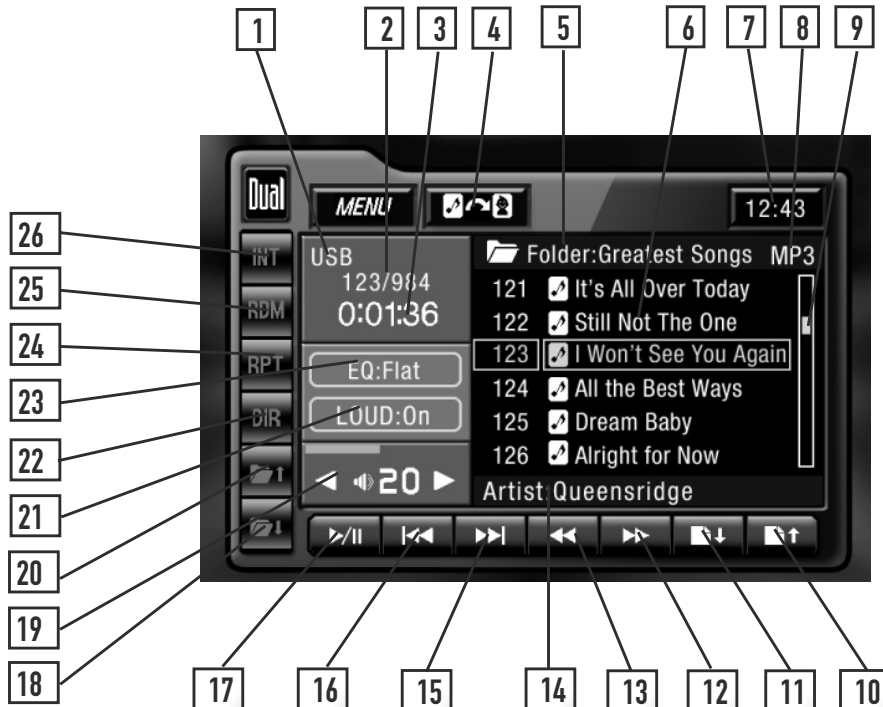











USB Mode

From the main menu, touch the **USB** icon on the screen to select USB mode.

- 1 **Current Source Indicator**
 Displays source currently playing.
- 2 **File Number Indicator**
 Displays current file number and total number of files in the current folder.
- 3 **Elapsed Time Indicator**
 Shows the elapsed time of the current song.
- 4 **Sound to Image Indicator**
 Press to switch from viewing sound files to image files.
- 5 **Folder Name**
 Displays the name of the currently selected folder.
- 6 **Playlist**
 Displays up to 6 files in order, with filename.
- 7 **Clock**
 Displays the current time.
- 8 **File Type Indicator**
 Displays type of file, either **MP3**, or **WMA** or **JPG**.
- 9 **Scroll bar**
 Indicates position of current file relative to the current folder.
- 10 **Page Up**
 Touch the  icon to see the previous 6 files in the current folder.



















USB Operation - OSD Overview

- | | |
|----|---|
| 11 | <p>Page Down
Touch the  icon to see the next 6 files in the current folder.</p> |
| 12 | <p>Fast Forward
Touch the  icon to fast forward at 2x speed. Each touch changes speed from 2x to 4x to 8x to 16x to 32x then to 1x play.</p> |
| 13 | <p>Fast Reverse
Touch the  icon to fast reverse at 2x speed. Each touch changes speed from 2x to 4x to 8x to 16x to 32x then to 1x play.</p> |
| 14 | <p>Information
Displays available ID3 tag information for the current song.</p> |
| 15 | <p>Track Up
Touch  to skip ahead to the next track.</p> |
| 16 | <p>Track Down
Touch  once to return to the beginning of the current track. Press again to return to the previous track.</p> |
| 17 | <p>Play/Pause
Touch  icon to temporarily stop or resume playback.</p> |
| 18 | <p>Previous Folder
Touch the  icon to select the previous available folder.</p> |
| 19 | <p>Volume Adjustment
Indicates current volume level. Turn the rotary or use the volume  or  on screen to adjust volume level lower or higher (0-46).</p> |
| 20 | <p>Next Folder
Touch the  icon to select the next available folder.</p> |
| 21 | <p>Loudness Indicator
Touch LOUD to turn the Loudness feature On or Off.</p> |
| 22 | <p>Direct Select Keyboard
Press DIR to display a numeric keyboard. Enter desired track number and touch OK to select it.</p> |
| 23 | <p>EQ indicator
Press EQ to enter the Audio Setup Menu.</p> |
| 24 | <p>Repeat
Touch RPT to repeat current track and again to repeat all tracks in the current folder. Touch RPT again to exit Repeat mode.</p> |
| 25 | <p>Random
Touch RDM to shuffle all tracks in the current folder and again to shuffle all tracks on the disc. Touch RDM again to exit Random mode.</p> |
| 26 | <p>Intro
Touch INT to listen to 10 seconds of each track in the current folder and again to preview all tracks on the disc. Touch INT again to exit Intro mode.</p> |

USB Operation



USB Connection	Connect a device using the USB port on the front of the XDVD9101. The unit will automatically switch to USB mode when a USB device is detected.
Sound to Image Indicator	<p>The Sound to Image indicator allows the selection of either sound (MP3 or WMA) or image (JPEG) files to be displayed in the Playlist.</p> <p> Indicates that sound files are currently displayed. Press to switch to viewing image files.</p> <p> Indicates that image files are currently displayed. Press to switch to viewing sound files.</p>
Folder List	Press the Folder Name area at the top of the screen to display the first six folders on the disc. Press  or  or use the ▲ and ▼ buttons on the remote control to view additional folders.
Navigating the Folder/Playlist	Once a folder is selected, the display will change to show the first six files in that folder. The current folder name will appear in the Folder Name area. Press  to navigate back to the previous folder, or press  to skip forward to the next folder.
Track Select	<p>Navigate through the Playlist by pressing  or  on the screen. Once the desired file is highlighted, simply touch the screen at the appropriate file name to begin playback.</p> <p>From the remote control: Press ▲ or ▼ to scroll through the files. When the correct file name is highlighted press OK.</p>
Direct Select	<p>To navigate forwards or backwards through all tracks, press  or  on the screen, front panel or remote control: Press  to skip to the next track. Press  to skip to the previous track.</p> <p>Note: Pressing  once will return to the beginning of the current track. Pressing it a second time will skip to the previous track.</p> <p>Note: Pressing  from the last track in one folder will advance to the first track in the next folder. Pressing  from the first track in a folder will return to the previous folder.</p>
Direct Track Entry	<p>Touch DIR to display a numeric keyboard. Enter desired track number in the current folder, and touch OK to select it.</p> <p>From the remote control: Use the numeric keypad to enter the desired track number in the current folder.</p>
Fast Forward/Fast Reverse	<p>Use the Fast Forward or Fast Reverse on-screen buttons to speed up the playback. Each subsequent press of the button will change the speed from normal to 2x to 4x to 8x to 16x to 32x and back to 1x.</p> <p>Press  to fast forward. Press  to fast reverse.</p>



USB Operation

Fast Forward/Fast Reverse

From the remote control:

Press ►► to fast forward.

Press ◀◀ to fast reverse.

Intro Mode

Touch **INT** on the screen to listen to all tracks in the current folder for 10 seconds at a time, starting from the next track. **Int Fol** will appear next to the **MENU** button while this feature is activated.

Touch **INT** again to preview all tracks on the disc. **Intro** will appear next to the **MENU** button while this feature is activated. Touch **INT** again to exit Intro Mode.

Random Mode

Touch **RDM** on the screen to shuffle all tracks in the current folder. **Rdm Fol** will appear next to the **MENU** button while this feature is activated.

Touch **RDM** again to shuffle all tracks on the disc. **Rdm All** will appear next to the **MENU** button while this feature is activated. Touch **RDM** again to exit Random Mode.

Repeat Mode

Touch **RPT** to repeat a track and again to repeat all tracks in the current folder. **Rpt Trk** or **Rpt Fol** will appear next to the **MENU** button while this feature is activated. Touch **RDM** again to exit Random Mode.

From the remote control:

Press ↻ to select between Repeat, Folder Repeat and Repeat Off modes.

Note: Shuffle and Repeat modes can not be used simultaneously and engaging one mode will cancel the other mode (if active.)

Repeat A-B

From the remote control:

Press **A→B** button once to select a start point. Press it a second time to select and end point. **RPT: A-B** will appear next to the **MENU** button. The loop will play from the start point to the end point until **A→B** is pressed again.

Play/Pause

Press **PLAY/PAUSE** to temporarily stop playback of the current track. Touching it again will resume playback.

From the remote control:

Press **PLAY** to temporarily stop and resume playback.

Stop

Press **BAND** to stop playback of the current track. Pressing **PLAY** at this point will resume playback. Press **BAND** a second time to stop playback completely. Play will restart from the beginning of the disc.

From the remote control:

Press ■ on the remote control to stop playback of the current track. Pressing **PLAY** at this point will resume playback. If ■ is touched a second time, playback stops completely and will restart from the beginning of the disc.

Media Compatibility - Disc



MEDIA				CD	
File Type				WMA	MP3
File System	ISO9660	Level 1, Level 2		✓	✓
		Level 3		X	X
	ISO9660 Extension	JOLIET	Playback	✓	✓
			Filename	32 bytes	32 bytes
	Other Extensions	ROME0	Playback	X	X
			Filename	X	X
Apple ISO		X	X		
File Extension	.mp3/.MP3/.Mp3/.mP3			X	✓
	.wma/.WMA			✓	X
	.rmp/.m4a			X	X
MPEG Format	MPEG 1			X	✓
	MPEG 2			X	✓
	MPEG 2.5			X	✓
Sampling Frequency	MPEG 1			X	8/11.025/12/16/22.05 24/32/44.1/48kHz
	MPEG 2			X	32/44.1/48kHz
	MPEG 2.5			X	8/11.025/12/16/22.05 24/32/44.1/48kHz
	WMA			22.05/32/44.1/48kHz	X
Bitrate	MPEG 1			X	8 ~ 320kbps
	MPEG 2			X	64 ~ 912kbps
	MPEG 2.5			X	8 ~ 320kbps
	WMA			32 ~ 192kbps	X
Other Information	Directory Depth			Unlimited	Unlimited
	File Name Length			23 bytes	23 bytes
	Total File Number			3000 files	3000 files
	Total Folder Number			256 folders	256 folders
	File Number via Folder			3000 files	3000 files
	MP3 ID3 TAG	ver.1.x		X	✓
		ver.2.x		X	v2.3
		Title, Artist, Album		X	✓
WMA TAG	Title, Artist		✓	X	



Media Compatibility - USB Flash Drive

MEDIA			USB Flash Drive		
File Type			WMA	MP3	
File System	FAT	FAT 12	X	X	
		FAT 16/FAT 32	✓	✓	
File Extension	.mp3/.MP3/.Mp3/.mp3		X	✓	
	.wma/.WMA		✓	X	
	.rpm/.m4a		X	X	
MPEG Format	MPEG 1		X	✓	
	MPEG 2		X	✓	
	MPEG 2.5		X	✓	
Sampling Frequency	MPEG 1		X	8/11.025/12/16/22.05 24/32/44.1/48kHz	
	MPEG 2		X	32/44.1/48kHz	
	MPEG 2.5		X	8/11.025/12/16/22.05 24/32/44.1/48kHz	
	WMA		22.05/32/44.1/48kHz	X	
Bitrate	MPEG 1		X	8 ~ 320kbps	
	MPEG 2		X	64 ~ 912kbps	
	MPEG 2.5		X	8 ~ 320kbps	
	WMA		32 ~ 192kbps	X	
Other Information	Directory Depth		Unlimited	Unlimited	
	File Name Length		23 bytes	23 bytes	
	Total File Number		3000 files	3000 files	
	Total Folder Number		256 folders	256 folders	
	File Number via Folder		3000 files	3000 files	
	MP3 ID3 TAG	ver.1.x		X	✓
		ver.2.x		X	v2.3
		Title, Artist, Album		X	✓
WMA TAG	Title, Artist		✓	X	

Notes: For best results, use the following settings when ripping MP3 files:
 128kbps or higher constant bit rate
 44.1kHz or higher sampling frequency

For best results, use the following settings when ripping WMA files:
 64kbps or higher constant bit rate
 44.1kHz or higher sampling frequency



Media Compatibility - Notes

Media Compatibility

The following types of discs are compatible:

- CD-DA, CD-ROM (ISO), CD-R, CD-RW
- DVD Video, DVD+R/RW, DVD-R/RW

The following types of discs/files are **not** compatible:

- WMA files that are protected by DRM (Digital Rights Management)
- WMA lossless format
- Discs recorded with Track At Once or packet writing
- MP3 PRO format
- MP3 playlists
- WAV format
- WMV format
- DivX format
- AVI format
- MPG format
- AAC format

Some recordable DVD's and CD's may be incompatible with this unit, depending on media type and recording method.

Playback Order

MP3/WMA playback sequence is based on recorded order of files and begins in the root folder of the disc or USB flash drive. Any empty folders or folders that do not include MP3/WMA/JPG files are skipped. Refer to your recording software's user's manual for more information.

Compatible Recording Formats

ISO9660 standards:

- Maximum nested folder depth is 8 (including the root folder).
- Valid characters for folder/file names are letters A-Z (all caps), numbers 0-9, and "_" (underscore). Some characters may not be displayed correctly, depending on the character type.
- This device can play back discs in Joliet and other standards that conform to ISO9660. MP3/WMA written in the formats other than the above may not play and/or their file names or folder names may not be displayed properly.

Additional MP3/WMA Information

An internal buffer provides ESP (Electronic Skip Protection) to virtually eliminate skipping.

When playing a disc recorded with regular audio files (CD-DA or .WAV) and MP3/WMA files, the unit will play the MP3/WMA files only.

Note:

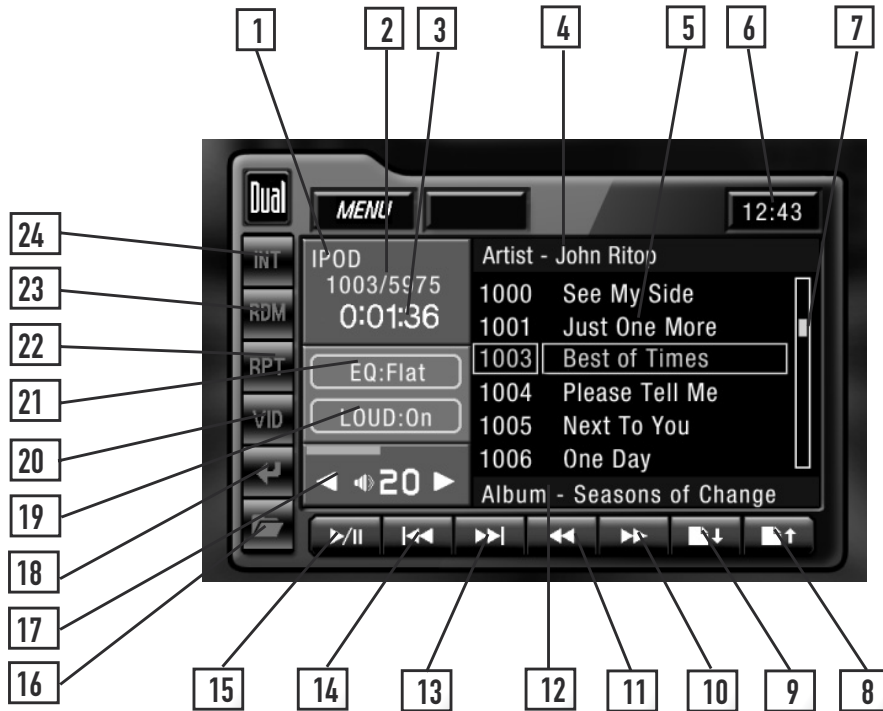

Some files may not play or be displayed correctly, depending on sampling rates and bit rates.

iPod® Operation - OSD Overview (Optional)



iPod Mode

From the main menu, touch the iPod icon on the screen.

- 1** Current Source Indicator
Displays source currently playing.
- 2** Song Number Indicator
Displays current song number and total number of songs.
- 3** Elapsed Time Indicator
Shows the elapsed time of the current song.
- 4** Artist Information
Displays the artist information for the currently selected song.
- 5** Playlist
Displays up to 6 songs/groups in order, with filename.
- 6** Clock
Displays the current time.
- 7** Scroll bar
Indicates position of current song in relation to the current folder.
- 8** Page Up
Touch the  icon to see the previous 6 songs.
- 9** Page Down
Touch the  icon to see the next 6 songs.

iPod® Operation - OSD Overview (Optional)



- | | |
|-----------|---|
| 10 | Fast Forward
Touch the ►► icon to fast forward at 2x speed. Touch again to cancel. |
| 11 | Fast Reverse
Touch the ◀◀ icon to fast reverse at 2x speed. Touch again to cancel. |
| 12 | Album Information
Displays available album information for the current song. |
| 13 | Track Up
Touch ►► to skip ahead to the next song. |
| 14 | Track Down
Touch ◀◀ once to return to the beginning of the current song. Press again to return to the previous song. |
| 15 | Play/Pause
Touch ► icon to temporarily stop or resume playback. |
| 16 | Group Select Mode
Allows selection of songs by various groups. |
| 17 | Volume Adjustment
Indicates current volume level. Turn the rotary or use the volume ◀ or ► on screen to adjust volume level lower or higher (0-46). |
| 18 | Return/Back
Touch ◀ to return to the previous group/menu. |
| 19 | Loudness Indicator
Touch LOUD to turn the Loudness feature On or Off. |
| 20 | Video Mode
Allows viewing of video files from the G5 iPod only. |
| 21 | EQ indicator
Press EQ to enter the Audio Setup Menu. |
| 22 | Repeat
Touch RPT to repeat current song. Repeat will appear next to the MENU button while this feature is activated. Touch RPT again to exit Repeat mode. |
| 23 | Random
Touch RDM to shuffle all songs. Random will appear next to the MENU button while this feature is activated. Touch RDM again to exit Random mode. |
| 24 | Intro
Touch INT to listen to 10 seconds of each song in order. Intro will appear next to the MENU button while this feature is activated. Touch INT again to exit Intro mode. |



iPod® Operation - (Optional)

iPod Connection

Use the included 2-wire iPod cable to connect an iPod to the XDVD9101. The unit will automatically switch to iPod mode when an iPod is connected.

Group Select Mode



The songs in the iPod are organized by groups. Touch the  on the screen to access the group select mode:

Once in Group Select Mode select one of the group types from the menu, then select an item in that group.

For example:

- Select the Artist group and the display will change to a list of available artists. Then select an artist from this list to hear some or all songs from that artist.
- Select the Song group to hear all songs on the iPod.

Return/Back

Touch the  on-screen button to go back to a previous menu. For example, when browsing songs from a particular artist in Artist group mode, touch  to return to the list of all available artists.

Page Up/Down

When there are more than 6 songs in a given group, the Page Up and Page Down on-screen buttons can be used to see the rest of the songs in the current group. Then use the Direct Select method to play a song from that group.

The Page Up and Page Down on-screen buttons can be used to preview the next/previous pages.

Note: The Page Up/Down buttons will not select a song, but simply display more songs in the group. If another song is not selected within 10 seconds of the last press then the screen will return to the currently playing song/group.

Song Select

From the remote control:

Press  to skip to the next song.

Press  to return to the beginning of the current song. A second press will skip to the previous song

Direct Select

To select a desired song from the song list, touch any of the displayed songs in the list.

From the remote control:

When the correct song is highlighted press **OK**.



iPod® Operation (Optional)



Song Control	<p>You can use the Fast Forward and Fast Reverse on-screen buttons to play a song forwards or backwards at a higher speed. Touch the same button a second time or press Play to return to normal playback.</p> <p>From the remote control: Press ►► to fast forward. Press ◀◀ to fast reverse.</p>
Intro Mode	<p>Touch INT on the screen to listen to all songs in the current group for 10 seconds at a time, starting from the next track. Intro will appear next to the MENU button while this feature is activated. Touch INT again to exit Intro Mode.</p>
Random Mode	<p>Touch RDM to shuffle the songs in the current group. Random will appear next to the MENU button while this feature is activated. Touch RDM again to exit Random Mode.</p>
Repeat Mode	<p>Touch RPT to repeat a song. Repeat will appear next to the MENU button while this feature is activated. Touch RPT again to exit Repeat Mode.</p> <p>From the remote control: Press ↺ to select Repeat. Press it a second time to disable Repeat.</p> <p>Note: Shuffle and Repeat modes can not be used simultaneously and engaging one mode will cancel the other mode (if active.)</p>
Play/Pause	<p>Press PLAY/PAUSE to temporarily stop playback of the current song. Press it again will resume playback.</p> <p>Press the PLAY/PAUSE button to pause or resume the song.</p> <p>From the remote control: Press PLAY to temporarily stop and resume playback.</p>

iPod® Operation (Optional)



Playing photo or video files from G5 iPod

Notes:

VIDEO/PHOTO FILES are only compatible with G5 iPod.

The iPod photo/video display of the in-dash unit will not operate while the vehicle is moving. This is a safety feature to prevent driver distraction. iPod photo/video functions will only operate when vehicle is in Park and the parking brake is engaged. It is illegal in most states for the driver to view video while the vehicle is in motion.



- Touch **VID** icon, iPod will disconnect and wait for video signal.
- Make sure **VIDEO OUTPUT** is turned on in your G5 iPod. Consult your iPod owner's manual for details.
- Press **PLAY** on your G5 iPod, photos or video will appear on the TFT.

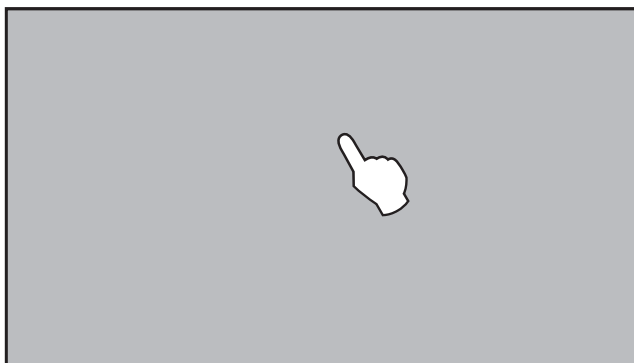

Releasing Video control from iPod
iPod will reconnect

- Touch anywhere on the screen during video playback to reconnect iPod and resume music playback.



iPod® Operation (Optional)



Selecting Music By:

- Playlists
- Artists
- Albums
- Genres
- Songs
- Composers



Touch desired Folder, music will begin to play after selection.

Character Support

Only alphanumeric characters can be displayed (ASCII type).

Artist Name and Album name will only be displayed if included with the song.

iPod Compatibility

The following models are supported:

- Third generation iPod - Version 2.3
- Fourth generation iPod - Version 3.1.1
- Fifth generation iPod - Version 1.1.2
- iPod Classic - Version 1.1.2
- iPod Touch - Version 1.1.4
- iPod Nano - Version 1.2.0
- iPod Nano (Second Generation) - Version 1.1.3
- iPod Nano (Third Generation) - Version 1.1.2
- iPod Photo - Version 1.2.1
- iPod Mini - Version 1.4.1

Refer to your iPod instruction manual for details on how to obtain the latest software.



Auxiliary Inputs - AV1 /AV2

Using A/V1 Input

Connect an optional audio/video source into the 3.5mm (front panel) input.

Select AV/1 from the Main Menu to listen to audio.

Engage parking brake as described on page 32 to watch video.

Adjust volume on the external audio source as needed (if connected to the headphone output).

Using A/V2 Input

Connect an optional audio/video source to the Auxiliary Input 2 (Red/White/Yellow RCA connectors). Refer to page 6 for details.

Select AV/2 from the Main Menu to listen to audio.

Engage parking brake as described on page 32 to watch video.

Rear Camera Operation - (Optional)

Using Rear Camera

Connect an optional rear camera to the Camera Input (Black RCA connector). Refer to page 6 for details.

The camera image can be reversed (if needed) in the Main Setup Menu. Refer to page 18 for details.

Manual selection - Touch CAMERA icon from the Main Menu to select camera mode. Touch the top left area on the screen to exit camera mode.

Auto Selection

The unit will automatically select camera mode when connected to the reverse lamp circuitry. Refer to page 6 for details. Anytime the reverse gear is selected, the panel will open and select camera mode automatically.



Limited One Year Warranty

This warranty gives you specific legal rights. You may also have other rights which vary from state to state.

Dual Electronics Corp. warrants this product to the original purchaser to be free from defects in material and workmanship for a period of one year from the date of the original purchase.

Dual Electronics Corp. agrees, at our option, during the warranty period, to repair any defect in material or workmanship or to furnish an equal new, renewed or comparable product (whichever is deemed necessary) in exchange without charges, subject to verification of the defect or malfunction and proof of the date of purchase. Subsequent replacement products are warranted for the balance of the original warranty period.

Who is covered? This warranty is extended to the original retail purchaser for products purchased and used in the U.S.A.

What is covered? This warranty covers all defects in material and workmanship in this product. The following are not covered: installation/removal costs, damage resulting from accident, misuse, abuse, neglect, product modification, improper installation, incorrect line voltage, unauthorized repair or failure to follow instructions supplied with the product, or damage occurring during return shipment of the product.

What to do?

1. Before you call for service, check the troubleshooting guide in your owner's manual. A slight adjustment of any custom controls may save you a service call.
2. If you require service during the warranty period, you must carefully pack the product (preferably in the original package) and ship it by prepaid transportation with a copy of the original receipt from the retailer to an authorized service center.
3. Please describe your problem in writing and include your name, a return UPS shipping address (P.O. Box not acceptable), and a daytime phone number with your shipment.
4. For more information and for the location of the nearest authorized service center please contact us by one of the following methods:
 - Call us toll-free at 1-866-382-5476
 - E-mail us at cs@dualav.com

Exclusion of Certain Damages: This warranty is exclusive and in lieu of any and all other warranties, expressed or implied, including without limitation the implied warranties of merchantability and fitness for a particular purpose and any obligation, liability, right, claim or remedy in contract or tort, whether or not arising from the company's negligence, actual or imputed. No person or representative is authorized to assume for the company any other liability in connection with the sale of this product. In no event shall the company be liable for indirect, incidental or consequential damages.

Specifications

DVD Player	<p>Frequency response: 10Hz-20kHz Channel separation @ 1kHz: >65dB D/A converter: 24 Bit</p>
FM Tuner	<p>Tuning range: 87.5MHz-107.9MHz Usable sensitivity: 8.5dBf 50dB quieting sensitivity: 10dBf Stereo separation @ 1kHz: 40dB Frequency response: 30Hz-13kHz</p>
AM Tuner	<p>Tuning range: 530kHz-1710kHz Usable sensitivity: 22uV Frequency response: 30Hz-2.2kHz</p>
Monitor	<p>Panel size: 7" (177.8 mm) diagonal measurement View angle (up/down/left/right): 30/60/60/60 Resolution: 480 W x 234 H Brightness (cd/m²): 350 Contrast ratio: 350:1 Elements: 336,960</p>
General	<p>Operating voltage: 11-16 VDC, negative ground Speaker output impedance: 4~8 ohms Line output voltage: 2 Volts Line output impedance: 200 ohms Chassis dimensions: 7" x 7" x 2" (178 x 178 x 51 mm)</p> <p>Design and specifications subject to change without notice.</p>



CEA-2006 Power Standard Specifications
(reference: 14.4VDC +/- 0.2V, 20Hz~20kHz)

Power Output: 17 Watts RMS x 4 channels at 4 ohms and $\leq 1\%$ THD+N
Signal to Noise Ratio: 80dBA (reference: 1 watt into 4 ohms)



Troubleshooting

General		
Problem	Cause	Action
Unit will not turn on (no power)	Yellow wire not connected or incorrect voltage Red wire not connected or incorrect voltage	Check connections for proper voltage (11~16VDC)
	Black wire not connected	Check connection to ground
	Fuse blown	Replace fuse
Unit has power (but no sound)	Speaker wires not connected	Check connections at speakers
	One or more speaker wires touching each other or touching chassis ground	Insulate all bare speaker wires from each other and chassis ground
Unit blows fuse	Yellow or red wire touching chassis ground	Check for pinched wire
	Speaker wires touching chassis ground	Check for pinched wire
	Incorrect fuse rating	Use fuse with correct rating
Unit has audio (but no video)	Parking brake safety circuit not connected Parking brake not applied	Check connections at parking brake Apply parking brake as described on page 32
No video display (when in reverse)	Reverse circuit not connected Vehicle is not in reverse	Check connections at reverse lamp Select reverse gear
DVD does not start playback	Physical defect in media Wrong region	Check media for scratches Use discs labeled "Region 1" or "All" only.
IR remote does not work	Dead battery	Replace battery
Excessive skipping	Unit is not mounted correctly	Check mounting sleeve
	Physical defect in media	Check media for scratches
Invalid Disc appears on display	Focus error or disc is in upside down	Press eject or RESET
Invalid Region appears on display	Region code error	Use only DVD's labeled "Region 1" or "All" only.
Front panel will not open/close	Front panel obstructed	Remove the obstacle and press OPEN to resume the monitor open/close sequence.



Notes



Notes



Dual Electronics Corp.
Toll Free: 1-866-382-5476

www.dualav.com
©2008 Dual Electronics Corp. All rights reserved.
NSA1008-V01
Printed in China